

JOURNAL OF ENGINEERING DRAWING

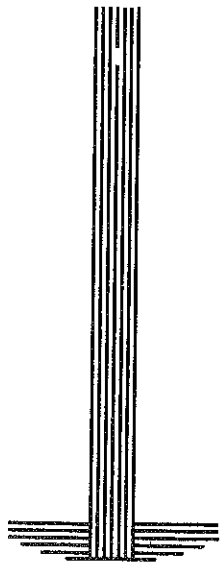

**PUBLISHED
BY
THE
DIVISION
OF
ENGINEERING
DRAWING
AND
DESCRIPTIVE
GEOMETRY
A S E E**

VOL. 12 NO. 2

MAY, 1948

SERIES NO. 35

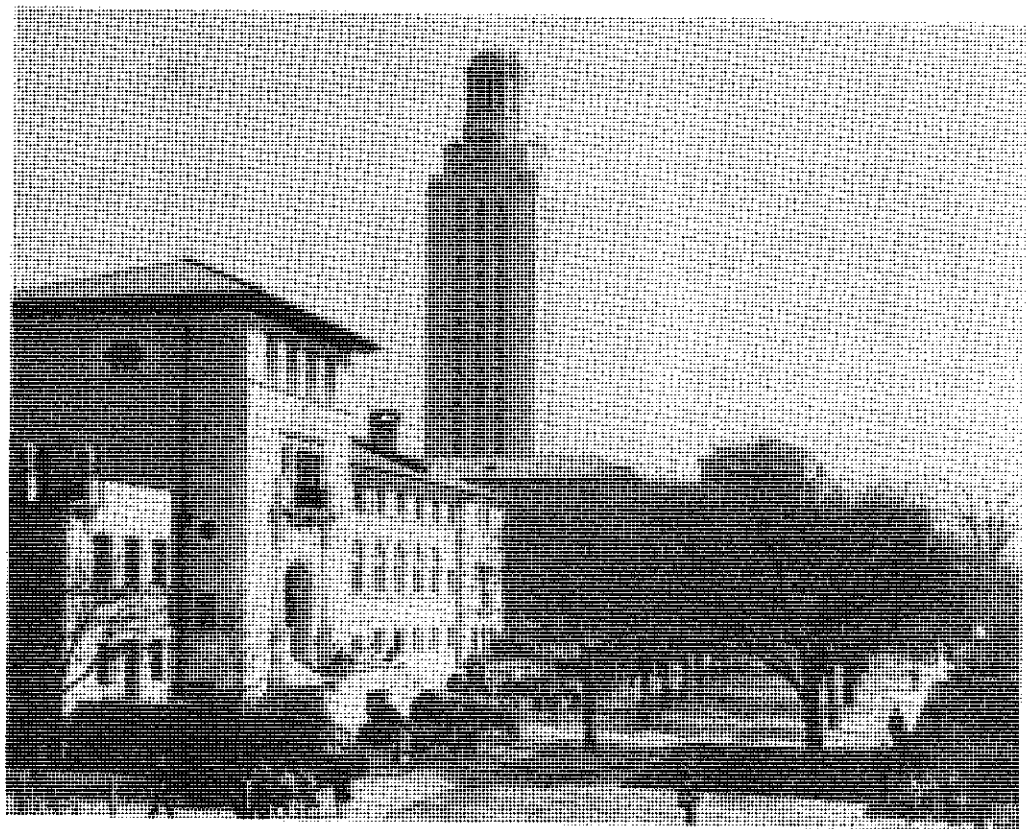

**TEXAS UNION BUILDING
HEADQUARTERS for the 1948 ANNUAL CONVENTION of A.S.E.E.
UNIVERSITY OF TEXAS
ADMINISTRATION-LIBRARY BUILDING IN BACKGROUND**

TECHNICAL DRAWING

Second Edition

By GIESECKE, MITCHELL and SPENCER

This engineering drawing book has taken its place as a leading text in the field. The second edition is distinguished for its clear and full explanations, superb drawings and excellent problems. There is new material on shop practices, expanded chapters on the geometry of technical drawing, intersections and developments, dimensioning and fasteners. Instruments and materials, instrumental drawing, lettering, multi-view projections and pictorial drawing are treated with unique fullness and clarity. \$3.75

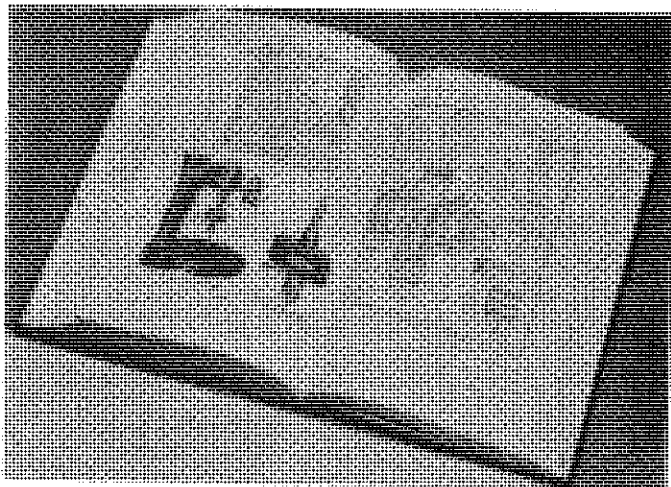

TECHNICAL DRAWING PROBLEMS *Revised Edition*

By GIESECKE, MITCHELL and SPENCER

The drawing fundamentals are covered more thoroughly and more comprehensively in the new edition of this workbook. There are now 105 rather than 93 sheets offering more advanced types of problems with increased emphasis on practical drafting room problems. Complete exercises in both vertical and oblique lettering are included in this manual in addition to problems on the other fundamental aspects of technical drawing. \$2.75

LETTERING EXERCISES are also available separately. Set, \$1.10

AIRCRAFT DRAFTING

By

HYMAN H. KATZ,
Allied School of Mechanical Trades, Inc. Formerly Supervisor of Engineering Training, Republic Aviation Corporation

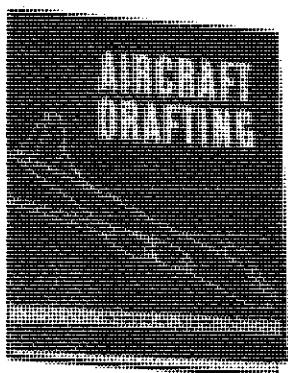

This book includes much practical information useful to the aircraft draftsman in addition to full training in the essentials of technical drawing and their application to aircraft. Considerable information is included on aircraft design, lofting techniques and processes, change groups, bills of materials, and weight calculations. Pictorial drawing, now widely used in industry and particularly in aircraft drafting, is stressed. Wherever possible, illustrations are used in place of lengthy explanations. \$5.00

THE BLUEPRINT LANGUAGE

By HENRY C. SPENCER, *Chairman of the Technical Drawing Dept., Illinois Institute of Technology* and

H. E. GRANT, *Associate Professor and Chairman of the Department of Engineering Drawing, Washington University*

This new combination text and workbook provides an unusually complete and realistic training in the essentials of blueprint reading for the machine industries. Over 100 major industrial companies have cooperated with the authors in the development of problems and illustrative material toward making *The Blueprint Language* meet the practical requirements of industry. Emphasis is placed on the visualization of machine parts and their uses. The book contains extensive chapters on shape description, including views of objects; normal, inclined, oblique, and cylindrical surfaces and edges; and sectional and auxiliary views. There is a whole section on modern shop processes. \$5.00

JOURNAL OF ENGINEERING DRAWING

PUBLISHED IN THE INTEREST OF TEACHERS OF ENGINEERING DRAWING
AND RELATED SUBJECTS

VOL. 12 NO. 2

MAY, 1948

SERIES NO. 35

CONTENTS

FRONTISPIECE: WE WISH PEACE by Prof. Franklin H. Thompson, University of California	Page 4
TEXAS CALLING by Prof. Frank A. Heacock, Princeton University.	Page 5
PRELIMINARY PROGRAM, Division of Engineering Drawing A.S.E.E. Annual Convention.	Page 5
TEXAS WELCOMES YOU by James D. McFarland, University of Texas.	Page 6
AN APPLICATION OF ADVANCED GRAPHICS: CRYSTALLOGRAPHY by Howard T. Evans, Jr., Massachusetts Institute of Technology.	Page 8
A GRAPHICAL SOLUTION FOR THE REDUCTION OF TWO NON-INTERSECTING NON-PARALLEL FORCES IN SPACE by Prof. E.J. Marmo, University of Nebraska	Page 11
NEWS.	Page 14
TEACHING TOLERANCES by Prof. J. Gerardi and E.J. Massard, University of Detroit.	Page 15
PROBLEM SOLUTION by Melvin Hainey, University of Texas	Page 18
THE NEWEST THING IN LETTERING by Francis W. Chamberlain and C. Ray Waddle, Lincoln, Nebraska	Page 19
HEAR YE! HEAR YE! by Prof. John M. Russ, University of Iowa	Page 20
A NON-CREDIT COURSE IN DRAWING IN LIEU OF HIGH SCHOOL DRAWING FOR STUDENTS DEFICIENT IN HIGH SCHOOL DRAWING by Robert R. Irwin, Assistant Professor of Mechanical Engineering, Oklahoma A & M College, Stillwater, Oklahoma	Page 25
A REPORT OF THE VISUAL AIDS COMMITTEE by Prof. H.P. Howe, Rensselaer Polytechnic	Page 26
SOLVE THIS ONE.	Page 34
BIBLIOGRAPHY REPORT by H.H. Fenwick, University of Louisville.	Page 35

Annual Subscription Price, \$1.00

PUBLISHED IN FEBRUARY, MAY, AND NOVEMBER BY
THE DIVISION OF ENGINEERING DRAWING AND DESCRIPTIVE GEOMETRY OF THE
AMERICAN SOCIETY FOR ENGINEERING EDUCATION

PUBLICATION COMMITTEE

T. T. Aakhus, Editor
University of Nebraska
LINCOLN, NEBRASKA

J. N. Wood, Advertising
Kansas State College
MANHATTAN, KANSAS

Ralph T. Northrup, Cir. & Treas.
Wayne University
DETROIT, MICH.

We wish peace;

but we wish the peace of justice, the peace of righteousness. We wish it because we think it is right, and not because we are afraid.

-THEODORE ROOSEVELT

Inaugural Address

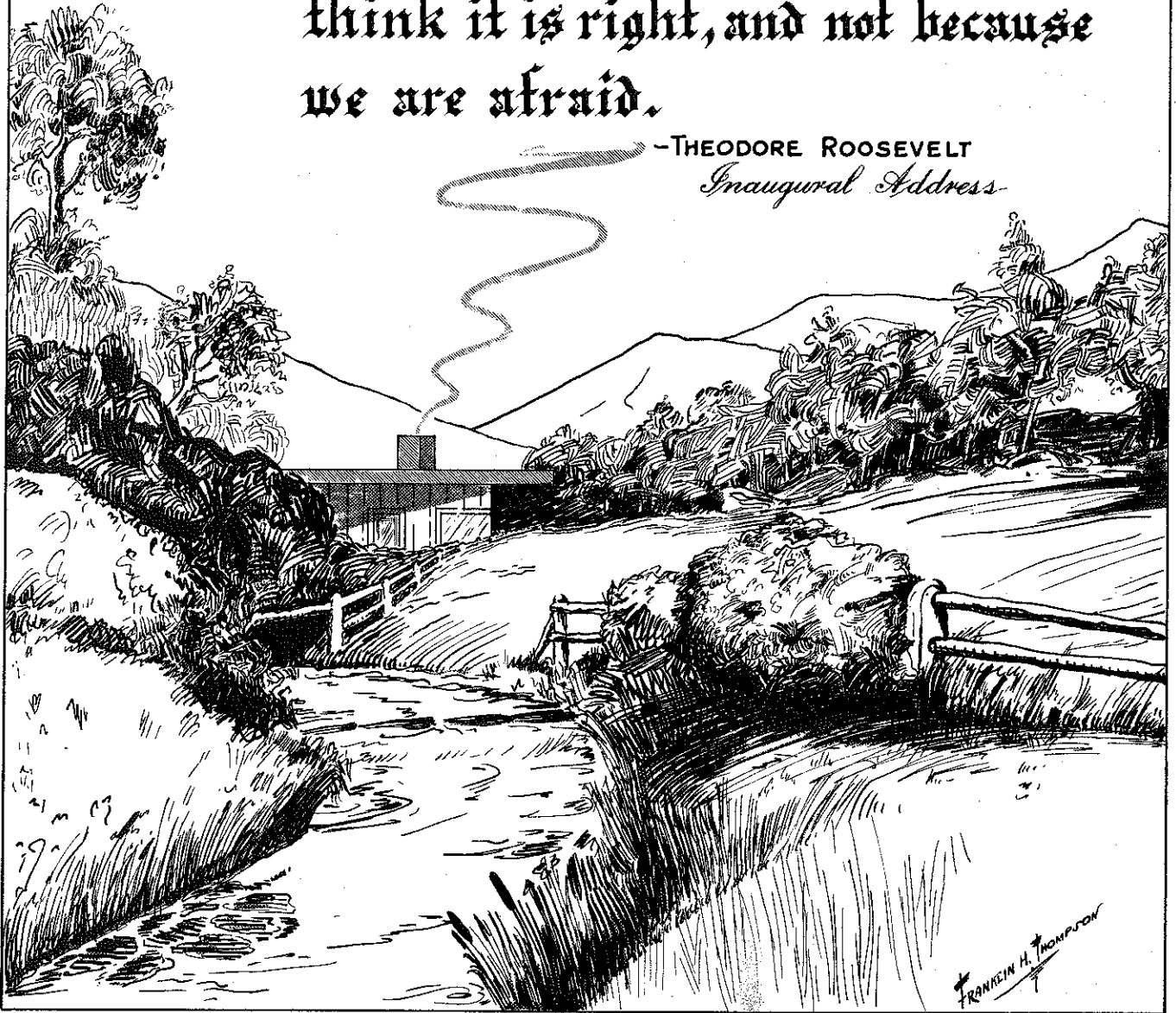

TEXAS CALLING

by

Prof. Frank A. Heacock,
Chairman, Division of Engineering Drawing A.S.E.E.

All teachers of engineering drawing, descriptive geometry and related courses are cordially invited to the Drawing Division conferences, luncheon and dinner to be held during the annual A.S.E.E. convention at the University of Texas June 14-18, 1948. Our Executive Committee has planned a program which will be interesting and worth while. It is printed on page 5 of this issue of the Journal of Engineering Drawing.

Three features of the program deserve special mention. On Monday afternoon there will be a joint conference of the Drawing Division with the Machine Design group of the Mechanical Engineering Division. Our colleagues in these two groups have kindred interests and it is essential that we keep in close touch with each other in order to coordinate our teaching properly. Therefore, this joint conference promises to be of mutual benefit.

The Drawing Division conference on Wednesday evening has a special appeal for teachers who are interested in visual aids. Professor Charles E. Rowe of the University of Texas, whose collection of teaching

models is regarded as one of the finest in America, will give a demonstration of his models at this conference.

The Teaching Clinic on Engineering Drawing and Descriptive Geometry, scheduled for Tuesday afternoon, is organized primarily to benefit young instructors who need counsel and guidance in their teaching problems, but it should be of interest and value to all of us who strive to improve our methods of instruction. A panel of competent and experienced teachers will be on hand and prepared to answer all questions. Teaching demonstrations at the blackboard will be given by an accomplished blackboard teacher. Ample time and opportunity will be allowed for general and specific questions and satisfactory answers, as well as appropriate discussion. It is our earnest hope that a large number of our colleagues, particularly the younger instructors, will attend this Teaching Clinic and take an active part in the proceedings.

Let us all get together and make this annual meeting a big success. I am looking forward to the pleasure of seeing you at Austin in June.

PRELIMINARY PROGRAM

Division of Engineering Drawing
A.S.E.E. Annual Convention
The University of Texas, Austin
June 14-18, 1948

Drawing Division Luncheon

Monday, June 14, 12:30 P.M.
Chairman, Frank A. Heacock, Princeton University
Secretary, Orrin W. Potter, University of Minnesota
Speaker, Edward M. Griswold, The Cooper Union
Subject, "Engineering Drawing an Experience in Engineering"
Report of Nominating Committee, Justus Rising, Chairman, Purdue University
Election of Officers

Joint Conference of Drawing Division with Machine Design Group of Mechanical Engineering Division

Monday, June 14, 2:00 P.M.
Chairman, Frank A. Heacock, Princeton University
Secretary, Ernst L. Midgette, Polytechnic Institute of Brooklyn
First Speaker, William H. Taylor, University of Alabama
Subject, "Some Relationships between Descriptive Geometry and Mechanics and Mathematics"
Second Speaker, Howell N. Tyson, California Institute of Technology

Subject, "Preparing the Beginning Engineering Student in the Drawing Class for His Later Work in Machine Design"
Third Speaker, Alexander W. Luce, Pratt Institute
Subject, "Standard Parts and Practices"
Fourth Speaker, Stephen B. Elrod, Purdue University
Subject, "Modern Dimensioning Practices"

Teaching Clinic on Engineering Drawing and Descriptive Geometry

Tuesday, June 15, 2:00 P.M.
Chairman, Walter H. McNeill, University of Texas
Secretary, Orrin W. Potter, University of Minnesota
Blackboard Demonstrator, Henry C. Spencer, Illinois Institute of Technology
Members of Panel to be announced later

Drawing Division Dinner

Wednesday, June 16, 6:00 P.M.
Toastmaster, Walter H. McNeill, University of Texas
Secretary, Orrin W. Potter, University of Minnesota

Speaker, Carl L. Svensen, Secretary-Director, Texas
State Board of Registration for Professional
Engineers
Subject, "Drawing in Engineering Education"

Drawing Division Conference

Wednesday, June 16, 8:00 P.M.

Chairman, Frank A. Heacock, Princeton University
Secretary, Orrin W. Potter, University of Minnesota

First Speaker, Charles E. Rowe, University of Texas
Subject, Demonstration of Models
Second Speaker, Paul M. Mason, A & M College of Texas
Subject, "An Adaptable Teaching Model for Orthographic
Views"
Third Speaker, E.G. Kirkpatrick, Purdue University
Subject, "A Rating Scale for Grading Engineering
Drawings"
Reports of Committees
Other Business

TEXAS WELCOMES YOU

by

James D. McFarland
Associate Professor of Drawing
The University of Texas

To the members of the Drawing Division of A.S.E.E., The University of Texas extends a hearty welcome. It will be a privilege to have you as our guests, and we hope to make your visit so enjoyable that you will decide to see more of our city and state after the convention has ended.

Austin, "the friendly city", and home of The University of Texas, may be reached by any of the well-known modes of transportation. The Missouri-Kansas-Texas Railway gives passenger service through the "Texas Special," and the Missouri Pacific Railway gives special passenger service through the "Sunshine Special." These two trains have a 22-hour service to St. Louis and 45-hour service to New York City. The Southern Pacific Lines offer excellent passenger service to all Southern, Western and Eastern points.

The Southwestern Greyhound Lines, Inc., Bowen Motor Coaches, and Kerrville Bus Company, Inc., furnish motor bus transportation in all directions.

High-speed transportation is furnished by several air lines which use the Robert Mueller Municipal Airport as a terminus. Austin is on the regular passenger, mail and express line between San Antonio and Dallas, and has connections with all other points.

If you plan to drive to the meeting then you will have a better opportunity to view the rolling hill country, the beautiful lake region and other spots of interest in and around Austin. The following highways pass through the city: U.S. 79, U.S. 81, U.S. 290, Texas 2 (Same as U.S. 81), Texas 20, Texas 29, Texas 43, Texas 71, Texas 165.

Within a radius of 60 miles of Austin there are five lakes with a combined shore line in excess of 600 miles. Lake Austin is within the city limits and Lake Travis, formed by the huge Mansfield Dam, is only 17 miles from the heart of the city. All Texas is proud of this chain of lakes, and the mountainous and wooded sections surrounding them contain an abundance of deer and wild turkey. Fishing in the lakes is excellent.

In and immediately adjacent to the city you will find recreational facilities of most every kind. Zilker

Park provides swimming, horseback riding, picnic tables, and several miles of roadway in the hilly section overlooking the Colorado River. Swimming is also available at Deep Eddy Bathing Beach. If you play golf you will find accommodations at the Municipal Golf Links or the Austin Country Club Links. Tennis courts are in abundance at the University campus and will be at your disposal. Good fishing may be had all around Austin.

Within the city are many points of interest. Among these are the Governor's Mansion, Elisabet Ney Museum, Texas Memorial Museum, Mt. Bonnell, the home of O'Henry, the Treaty Oak and others too numerous to mention. Austin has the unique distinction of being the only city in the world lighted by "artificial moonlight". This is accomplished by the tower lights - lights of 9,600 candlepower on top of 165 ft. steel towers - scattered about the city.

Courses in engineering were first given at The University of Texas in 1894. Since that time well over 3000 degrees in the various branches of the profession have been conferred. Degrees are offered in eight branches of engineering and in Architecture. The current enrollment in the College of Engineering is 3,681 students.

The Main Campus of The University covers about 200 acres. We have many fine buildings which we would be happy to show you, and some temporary wooden ones erected this past summer that will probably remind you of some which you, too, have had to use in order to take care of the heavy post-war enrollment. There are 17,343 students in attendance at the Main University this semester.

Housing accommodations for you are available at hotels, tourist courts, and dormitories. Most of these are within two miles of the campus.

Meals, other than those scheduled, may be had on or near the campus or down town. Prices are reasonable.

Entertainment has been provided for everyone. Arrangements have been made to take care of children if this service is desired.

(Continued on page 14)

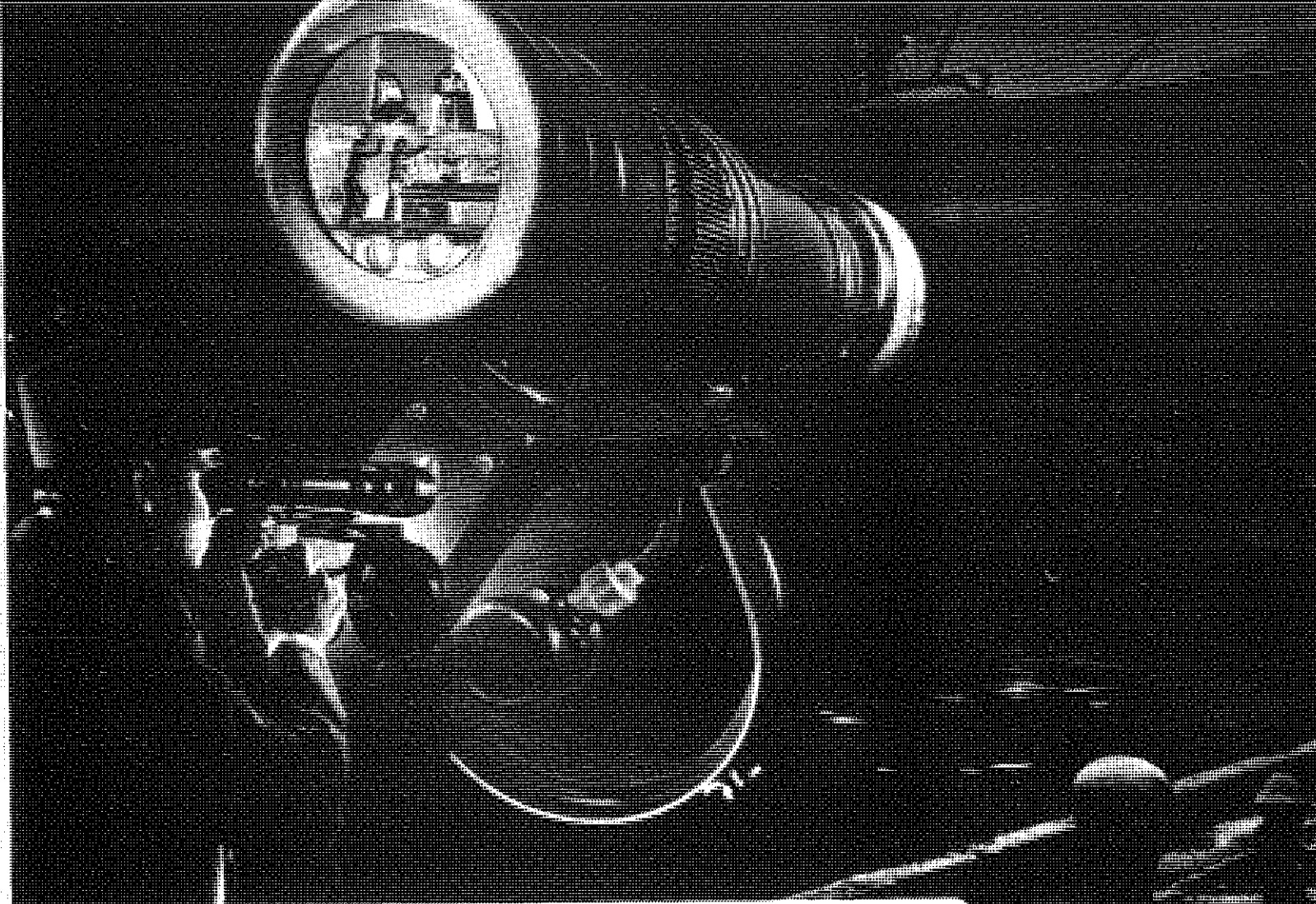

WITH A LIGHT THAT CANNOT BE SEEN

Photo courtesy Radio Corporation of America

AMERICAN SOLDIERS in pitch dark able to see clearly the enemy ahead; scout cars speeding at 50 miles an hour along blacked out roads in perfect safety; officers of the law seeing clearly the operations of hijackers "hidden" by night: these are some of the miracles performed with the help of the infrared telescope. Workers in the dark are thus aided by a light that cannot be seen.

It can be said that young lads, on the way to take their place in the world, possessed of hungers for they know not what, driven by innate energies they know not where . . . are just as truly working in the dark. And so, too, educators must illuminate the obscure face of the future for them . . . using a light that cannot be seen, the light of searching and sympathetic wisdom. Only then can a boy establish a goal that is socially useful and a personal recompense. Only thus can stumbling feet be kept on the road.

And how can the educator's responsibility be discharged, how can the unseen light be effectively used, if not with and through the familiar things of school routine? For example, the drawing instruments a youngster will use when he comes to mechanical drawing class . . . their very

selection can be an opportunity which gives a momentary glimpse into the beyond. These are tools of engineering, and engineering is the great hero of today and tomorrow. Shall its very instrumentality be chosen carelessly, treated with equal disregard? Or can the fact of great achievement be reflected into the life of the youngsters by a beautiful set, an exquisitely wrought set, a set to proudly possess the rest of the student's life . . . a set that may well be a touchstone, the source of another light that may also help to lead the lad onward and forever upward? Upon the right selection here vital values rest.

EUGENE DIETZGEN CO.

Chicago · New York · San Francisco · New Orleans · Pittsburgh
 Los Angeles · Philadelphia · Washington · Milwaukee
Dealers in All Principal Cities



DIETZGEN
 EVERYTHING FOR
 DRAFTING AND SURVEYING

AN APPLICATION OF ADVANCED GRAPHICS: CRYSTALLOGRAPHY¹

by

Howard T. Evans, Jr.

Section of Graphics, Massachusetts Institute of Technology

INTRODUCTION

Nowadays we are beginning to appreciate the value of graphics as a tool of science, and realize that graphical mathematics is a science itself, a well defined branch of mathematics. That graphics has not been recognized as a science, as mathematics has been, is a great pity, for each of the sciences has had to develop its own graphical methods empirically. This is a process which has generally been rather inefficient, because, under these conditions, the graphical methods are considered secondary to the problems to which they are applied, and hence have not been subjected in many cases to intensive development. This situation has been clearly pointed out by John T. Rule² in an article in which he urges that the science of graphics be recognized and developed to serve other sciences in the solution of problems for which up to now these sciences have been using makeshift methods.

In the paper by Rule just mentioned, there is a reference to crystallography as an example of one of the sciences in need of highly developed graphical methods. It so happens that crystallography is one of those sciences which has realized the power and indispensability of such methods and has indeed developed them to a very high degree. The science of crystallography might stand as a model for the manner in which graphics has been applied. On the other hand, unlike most other sciences, crystallography has made rather poor use of algebraic mathematics, preferring rather the graphics. It is the purpose of the present paper to describe some of the graphical methods of crystallography and to illustrate the great power of such methods.

The crystal, as a body bounded by plane faces, very early attracted the attention of graphically minded men. It was not until about 1800, however, that the naturalist Hauy discovered that unlike Nature's other graphical expressions, crystal forms are rigidly defined mathematically on the basis of a regular internal periodicity of structure. Following this discovery, crude graphical and mathematical methods were developed for measuring and defining crystals. Since the form of a crystal is characteristic of the

substance of which it is composed, drawings of crystals were found to be very valuable in the descriptions of minerals and chemical compounds. Around 1880, V. Goldschmidt began making his contributions to graphical methods of crystal measurement and drawing. Goldschmidt brought about a revolution wherein makeshift methods were replaced by fundamental methods. It may be said that the present state of graphical crystallography is the result almost entirely of the work of this one man.

In 1912, it was found by von Laue that X-rays could be diffracted by the periodic structure of a crystal, just as light is diffracted by a ruled grating. Physicists and mathematicians at this point started studying this phase of crystallography. Because of the interplay of the different sciences, the mathematical state of crystallography has been tremendously improved in recent years.

Crystallography today thus is divided into two broad subdivisions, which are, of course, closely interrelated: crystal morphology, the study of the external form of crystals; and X-ray crystallography, the study of the internal structure of crystals. In the former, the single crystal is measured with an arm protractor or by more refined methods, represented graphically by certain types of projections, and characterized by the properties of these projections. In the latter, the crystal is bathed in a beam of X-rays, the diffracted beams recorded on photographic film, and the resulting data combined by various graphical and mathematical means to yield the structural constants of the crystal, and ultimately, the precise locations of all the atoms in the crystal. The graphical methods in the process of X-ray analysis of crystals are among the most powerful and magnificent ever developed in any field, but unfortunately, these lie beyond the scope of this paper. Here we must confine ourselves to crystal morphology, and survey the methods developed by Goldschmidt and his followers. These methods involve the problems, familiar to us, of measuring angles and lengths in space, and projecting solid bodies orthographically onto planes.

¹Presented at the Annual Convention of the A.S.E.E. at Minneapolis, Minnesota, June 1947.

²John T. Rule, "Graphics Re-examined", J. Eng. Draw., Feb. 1947, pg. 1.

ANALYTIC GEOMETRY OF CRYSTALS

Since crystals are bounded by plane faces, it is natural to refer these planes to three axes in space and define them by their intercepts on these axes. The axes in general will not be Cartesian, but may be inclined, and measured with different scales. The choice of axes will depend on the symmetry of the crystal being measured; the interaxial angles α , β and γ , and axial scales, linear in the ratio $a : b : c$, depend on the substance forming the crystal and are characteristic of that substance. When a crystal face is extended to intersect these three axes, three intercepts will be determined; as the crystal grows, these intercepts will change, but their ratio remains constant. If the interaxial angles and scales are properly chosen, it turns out that this ratio may always be expressed by simple whole numbers ("Law of Rational Intercepts").

For many decades, crystals were treated directly in this way, and the characteristic interaxial angles and scales were related to the dihedral angles between faces by brute force spacial trigonometry or elementary analytic geometry. When crystal drawings were made, the three axes were set up in pictorial form by a method known as the "clinographic" projection. The intercepts of each plane were laid off on the projected axes, and the intersections of the planes determined from their traces on the axial planes; thus the crystal was built up edge by edge. If the crystal was at all complex, the trigonometry and crystal drawing by axial intercepts became very tedious and trying. Clinographic projection was described in the fifth edition of Engineering Drawing by French, but has been wisely omitted in recent editions.

PROJECTION METHODS

Crystals being solid bodies, they are characterized by three dimensions. The three dimensions for any crystal face may be defined as follows: the strike of the face (azimuth angle); the dip of the face (inclination angle); and the distance of the face from the origin. From our discussion, we have seen that the internal structure of the crystal determines the first two of these dimensions; thus the dihedral angles are strictly controlled. But the last dimension is not dependant on the crystal structure, but on the rate of growth of the face, which varies with many factors of circumstance. Thus, the mathematical definition of a crystal, as an expression of its internal structure, is concerned with only two dimensions, the first two listed above. The dihedral angles between faces are a function of these two dimensions and therefore are of prime importance; but the shapes and sizes

of the faces depend on the third, and have no significance for our present purpose.

These considerations suggest that there may be some convenient way of representing the two dimensions we are interested in on a two-dimensional surface, the plane of the paper. Actually, two such graphical transformations, the gnomonic and stereographic projections, have been found very useful. We shall now see how each is derived and what briefly are their properties. Many readers are no doubt familiar with these same projections as used in other fields, especially cartography, but their application to crystallography is particularly dramatic.

If we establish an origin somewhere near the center of the crystal, we may erect at this point a line normal to each face on the crystal. Each of these vectors will have dimensions equivalent to those of the face, angle of azimuth and angle of inclination; if the length of the vector is not limited, the third dimension remains undetermined, in accord with our plan. Each face on the crystal will then have a corresponding perpendicular, and we may think of the crystal in terms of these two-dimensional vectors alone. Now, suppose that a sphere of unit radius is drawn with its center at the origin. As shown in Figure 1, each vector will pierce the surface of the sphere in a point. The crystal is thus transformed into an arrangement of points on the two-dimensional surface of the sphere, each point p_{sp} representing a

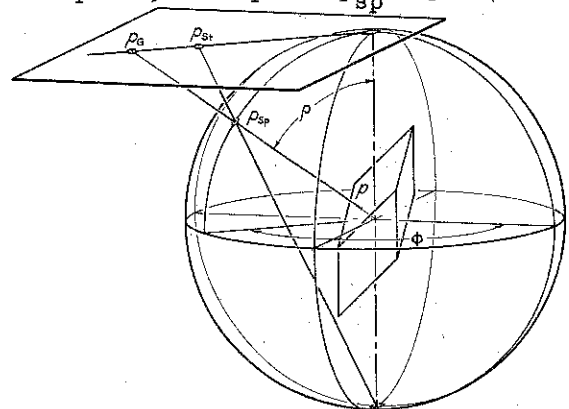

Fig. 1. Construction for the spherical, gnomonic and stereographic projections.

crystal face p . If a convenient coordinate system is set up, the position of each point can be measured in terms of two angles corresponding to the longitude and latitude angles used to measure the position of points on the earth's surface. The azimuth angle is designated ϕ , measured from 0° to 360° , and the inclination angle p , measured from 0° to 180° . The latter, corresponding to latitude, is measured from the north pole, instead from the equatorial plane.

(Continued on page 21)

DESCRIPTIVE GEOMETRY

By JOHN T. RULE and EARLE F. WATTS,
MASSACHUSETTS INSTITUTE OF TECHNOLOGY

A highly teachable text that trains the student to solve engineering problems by the simplest graphical methods. Unlike texts that present the "Direct" or the "Mongean" method alone, this book does not limit the student to one plan of attack. The authors believe that all methods are part of the subject -- consequently the study points out the various possibilities of attack on the basic group of problems underlying the subject.

- Emphasis on the solution of problems.
- Inclusion of the properties of plane figures as a proper part of a textbook on graphical methods.
- Twenty-page discussion of stereoscopic drawing.
- Excellent organization and development of material.
- For use as a basic text in Descriptive Geometry, Engineering Drawing, or Graphics courses.

301 Pages • 6" x 9"



PROBLEMS IN DESCRIPTIVE GEOMETRY

By EARLE F. WATTS and ARTHUR L. GOODRICH,
MASSACHUSETTS INSTITUTE OF TECHNOLOGY

This helpful set of problems is correlated with DESCRIPTIVE GEOMETRY by Watts and Rule. The problem sheets bear group numbers and references which refer to chapters and pertinent paragraphs in that text.

There are 64 plates. Sufficient variety and quantity in problem matter is achieved,

many plates having as many as seven individual problems.

As a student aid, certain problems are included which require both a graphical and an analytical solution. A form for plotted problems enables the instructor to assign problems of his own choice.

64 Plates • 8½" x 11"

Send for Your Examination Copies

PRENTICE-HALL, Inc.

70 FIFTH AVENUE

NEW YORK 11

A GRAPHICAL SOLUTION FOR THE REDUCTION OF TWO NON-INTERSECTING NON-PARALLEL FORCES IN SPACE

by

E. J. Marmo
Associate Professor of Engineering Mechanics
University of Nebraska

When a rigid body is subjected to the action of forces which are directed so that they are neither parallel nor intersecting, the problem in the analysis of external force action can be resolved into one of four possibilities, depending upon the magnitude, direction and point of application of the forces. The reduction may result into:

- (1) A single force
- (2) A single torque or couple
- (3) A system of force in equilibrium
- (4) A force and a couple

The first three possibilities represent conditions which will exist for special cases only. The fourth possibility is one which covers the general cases and is to be the one which concerns the discussion which follows.

Regardless of how complicated the force system may be in dealing with non-concurrent and non-parallel forces in space, these forces are the equivalent to a single resultant force and a single resultant torque. If the torque can be made to act at right angles to the direction of the forces we have the simplest case in the reduction - a wrench.

The use of graphical solutions has been extensively used by the designer in analyzing the external force actions on bodies. It seems that this type of a solution has been restricted mainly to forces which lie in a single plane. Some use has been made of graphical solutions dealing with problems having concurrent forces in space.

The application of graphical solutions to problems dealing with non-intersecting non-parallel forces in space has been very much neglected. It is my belief that with a proper knowledge of mechanics combined with a proper knowledge of the principles of descriptive geometry considerable time and effort can be saved by the engineer if he resorts to graphical solutions for problems of this type.

In order to more fully appreciate the possibility of using the graphical solution in preference to the analytical solution it might be of interest to briefly outline the steps involved in a mathematical solution.

The two forces AB and CD act on a rigid body as shown by Fig. 1. AB has a magnitude of 2310 lb and bears N54° 30'E with a slope of 28° 10' below the horizontal. CD has a magnitude of 1655 lb and bears N39° 15'E with a slope of 9° below the horizontal.

1. Select any convenient point such as A and draw the x, y and z axes through that point.
2. Resolve the force CD so that it will consist of a parallel force AD₁ through the

point A and a couple determined by the forces CD and AD₂.

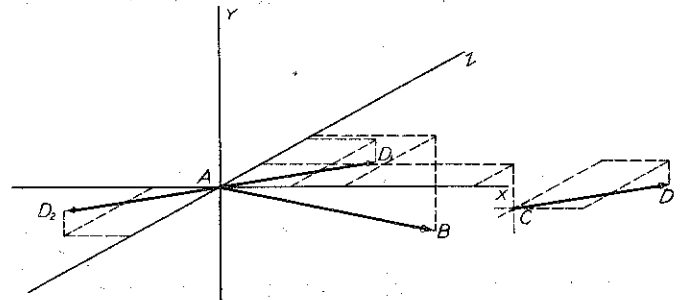

Fig. 1

3. The force system now consists of two concurrent forces AB and AD₁ and a couple made up of the two equal and opposite parallel forces CD and AD₂. The external effect on the body caused by this new arrangement of forces remains unchanged from the original condition.
4. Find the resultant of the two concurrent forces AB and AD₁ by resolving each force into components parallel to the x, y and z axes. Then find ΣF_x , ΣF_y , ΣF_z . The resultant can be determined by the equation $R = \sqrt{\Sigma F_x^2 + \Sigma F_y^2 + \Sigma F_z^2}$.
5. Find the angle that the resultant makes with the x, y and z axes. If the angles which the resultant makes with the x, y and z axes are respectively α , β , and γ . The angles are derived from the equations.

$$\cos \alpha = \frac{\Sigma F_x}{R}$$

$$\cos \beta = \frac{\Sigma F_y}{R}$$

$$\cos \gamma = \frac{\Sigma F_z}{R}$$

6. In general the couple determined by the two equal and opposite parallel forces CD and AD₂ will not cause rotation at right angles to the resultant force R passing through the origin.
7. The direction of the plane of the couple can be determined by finding the angles which the normal to this plane, passing through the origin, makes with the x, y and z axes. The normal to the plane is also the vectorial representation of the couple. It is explained in Fig. 4.

8. For the general case the vector representation of the couple and the resultant force vector R do not make the same angles with the x , y and z planes. It then becomes necessary to combine the two vectors so that the couple lies in a plane perpendicular to the force R . The position of R has to be displaced parallel to itself in order to meet this condition.

The procedure outlined above is one analysis for arriving at the reduction of forces in space which are non-concurrent and non-parallel. The condition to which it reduces the forces is one in which we have translation along one line such as F and a minimum torque M_R in a direction at right angles to the line. This condition is shown by Fig. 2. It can be seen

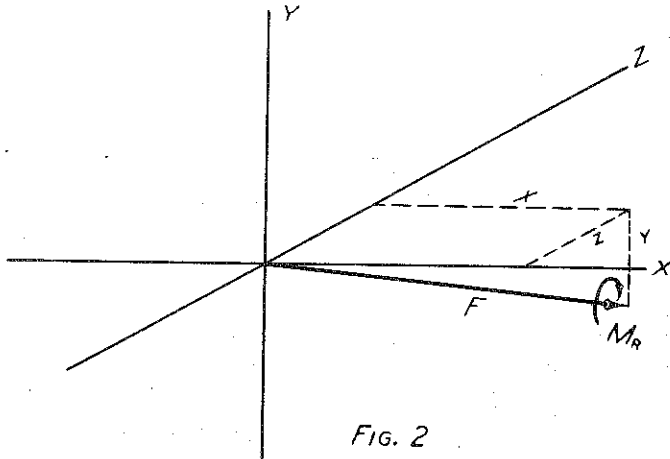

FIG. 2

from the preceding steps that there are numerous space relationships which involve the use of trigonometry and algebra. The work becomes very tedious and for this reason such problems can often be solved more readily with the use of a graphical method.

GRAPHICAL SOLUTION

The application of descriptive geometry to the solution of the same problem that has been previously mentioned is shown by Fig. 3.

GIVEN: Two forces AB and CD acting at given distances on a rigid body. The 2310 lb force AB applied at point A has a slope of $28^\circ 10'$ below the horizontal and has a bearing of $N54^\circ 30'E$. The 1655 lb force CD applied at point C has a slope of 9° below the horizontal and has a bearing of $N39^\circ 15'E$.

REQUIRED: The reduction of these two forces which are non-parallel and non-intersecting to their simplest form; namely, a single resultant force and a single resultant torque as shown by Fig. 2.

ANALYSIS: (1) The two given forces AB and CD are represented by vectors in the top and front view of Fig. 3 according to the specified directions and to a specified scale.

(2) Through any convenient point on AB , such as A , draw two equal and opposite force vectors, AE and AF , parallel to and equal to CD . This is

done in both the top and front views. The external effect on the rigid body has not changed due to this transposition.

(3) The composite vector forces acting on the rigid body can now be considered to be made up of two concurrent vector forces AB and AE and a couple represented by the two vectors CD and AF which are opposite in sense and parallel to each other.

(4) AG the resultant of the vector force AB and AE is determined by the use of the parallelogram of forces shown in the top and front views.

(5) The auxiliary view taken adjacent to the front view is drawn in the direction of a frontal line CM of the plane of the couple (two parallel force vectors) and it shows the plane of the couple appearing as an edge. This view is labeled with the subscript A_1 .

(6) The oblique view labeled with subscript O_1 is taken from the auxiliary view (A_1) in a direction perpendicular to the plane of the couple. This view shows the true length of the force vectors making up the couple and it also shows the true distance between the vectors. This scaled distance (1.78 in.) times the magnitude of the force vector $C_{O_1} D_{O_1}$ or $A_{O_1} F_{O_1}$ (1655 lb) gives the moment of the couple (2950 lb in.).

(7) The oblique view labeled with the subscript O_2 is taken from the oblique view (O_1) in a direction perpendicular to the resultant $A_{O_1} G_{O_1}$. This view shows the plane of the couple appearing as an edge and it also shows the true length and true angle that the resultant AG makes with the plane of the couple. $A_{O_2} G_{O_2}$ has a magnitude of 3890 lb and makes an angle of 12° with the plane of the couple determined by the vector forces $C_{O_2} D_{O_2}$ and $A_{O_2} F_{O_2}$.

(8) The next step involves the representation of a couple by a vector. Fig. 4 shows an example of how this is done. If two forces such as F_1 and F_2 form a couple the magnitude of the couple is F_1 or F_2 times y . If F_1 is in pounds and y is in inches the magnitude is in lb in. The magnitude of this couple can be represented by a vector V by drawing to a definite scale (representing lb in.) a line which is perpendicular to the plane of the couple and which is directed so that it projects outward from the view of the plane which shows the couple action appearing in a counterclockwise direction.

(9) Referring to Fig. 3 again, and to the oblique view O_2 , the couple having a magnitude of 2950 lb in. is represented by the vector $A_{O_2} J_{O_2}$.

(10) With the use of the triangle of forces, the vector $A_{O_2} J_{O_2}$ is resolved into two components, a component $A_{O_2} H_{O_2}$ in a direction collinear with the resultant force $A_{O_2} G_{O_2}$ and the other component $H_{O_2} J_{O_2}$ in a direction perpendicular to the resultant. The magnitude of AH equals 625 lb in. and the magnitude of HJ equals 2885 lb in.

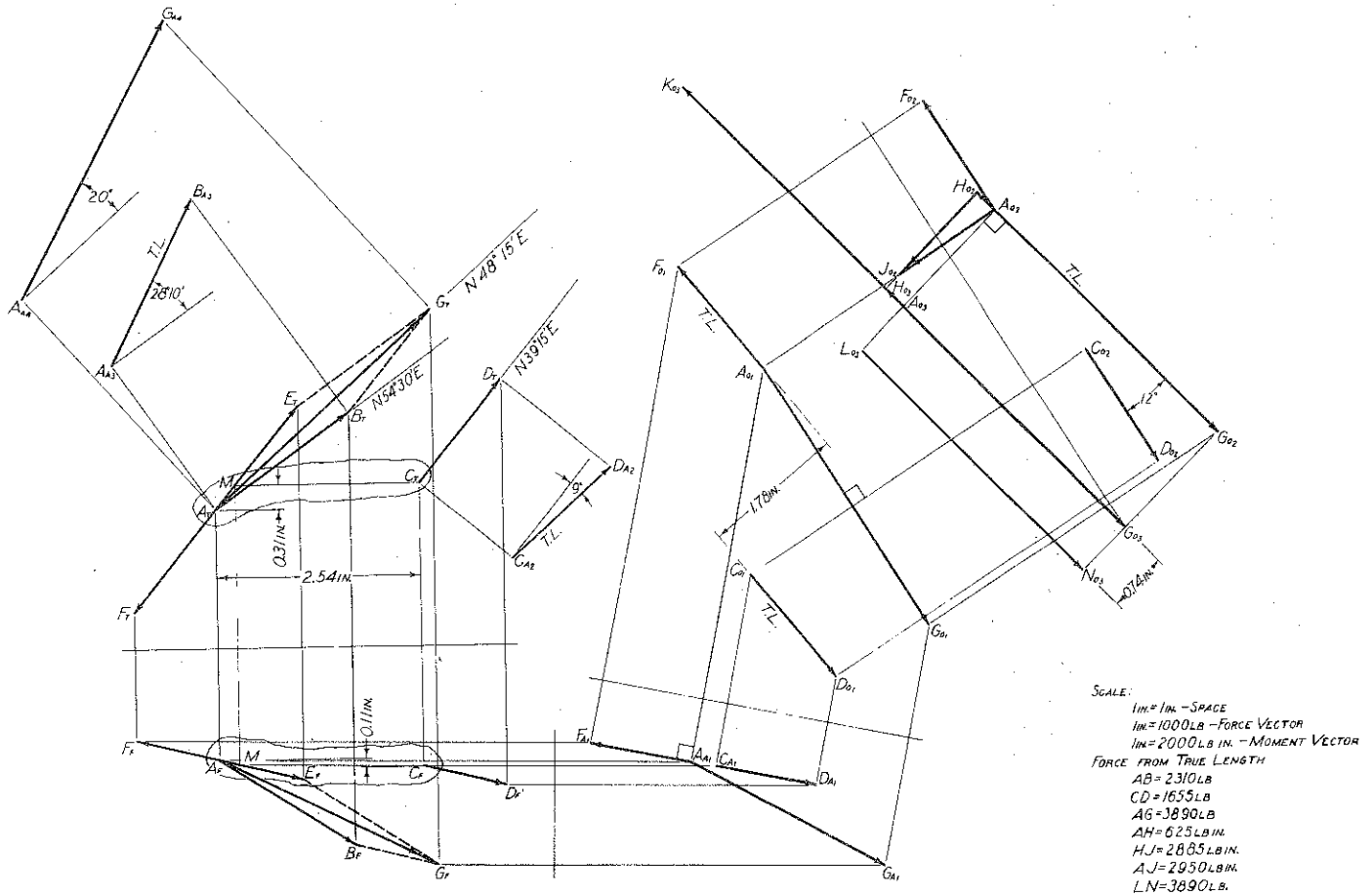

REDUCTION OF TWO NON-INTERSECTING, NON-PARALLEL FORCES TO THE SIMPLEST FORM

GRAPHICAL SOLUTION

FIG. 3

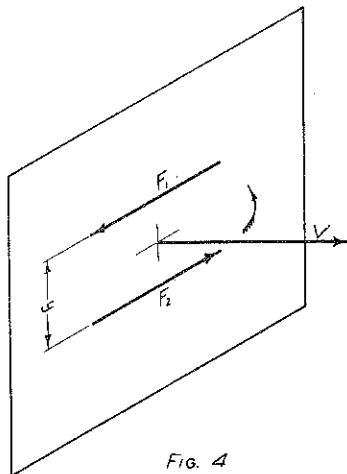

FIG. 4

(11) The oblique view O_3 is taken in a direction perpendicular to the resultant AG in the oblique view O_2 . In this third oblique view the resultant AG still appears in its true length. The couple vector AH is also in its true length in this view and still collinear with AG . The couple vector HJ having a magnitude of 2885 lb in. is resolved back into two forces $A_{O_3} K_{O_3}$ and $L_{O_3} N_{O_3}$ parallel to each other and opposite in sense. AK is equal to and collinear with AG but opposite in direction. The distance of 0.74 in. is determined so that the magnitude of the couple represented by the vector HJ (2885 lb in.) could be obtained by two forces AK and LN each of which is equal in magnitude to AG . In other words the magnitude of HJ (2885 lb in.) divided by AG (3890 lb) is equal to 0.74 in.

(12) The condition which now exists in the oblique view O_3 is one in which two equal collinear forces

AG and AK cancel out because they are opposite in sense. This leaves the two vectors LN and AH. LN, by construction, is equal to AG and therefore equal to 3890 lb. The direction of LN is also unchanged from that of AG but the point of application has changed. AH is the vector representation of a couple and is equal to 625 lb in. The plane of the couple representing AH is perpendicular to the direction of the vector LN. This reduction brings about the simplest form of the two original forces AB and CD.

It is evident from the foregoing discussion and the accompanying solution that the application of descriptive geometry offers a splendid opportunity for arriving at a rapid solution for problems dealing with the analysis of force action in space. The accuracy attained will naturally depend upon the precision in the workmanship and also upon the selection of suitable scales. It will conform to the same degree of accuracy that the graphical solution has to a mathematical solution for problems dealing with forces lying in one plane.

NEWS

Professor Hoelscher informs me that the manuscript of the proceedings of the 1946 summer school are now in his hands. The material is to be re-edited for possible publication this coming fall.

An institute for effective teaching has been established at the University of Detroit through the effort of Dean Clement J. Freund of the College of Engineering, as a means of aiding faculty members at giving a maximum of instruction in the classroom.

Among the members of the faculty asked to lecture at these meetings is Jasper Gerardi, Assistant Dean of the College of Engineering and Chairman of the Department of Engineering Drawing.

Fred Higbee and John Russ of Iowa suggested a "new equipment" or "what's new and interesting" department in the Journal of Engineering Drawing. Submit any interesting items that you wish to bring to the attention of the Editor of the Journal.

A General Engineering Department has been organized at the University of New Mexico. Professor J. Humerich is head of the department. This department teaches courses in Engineering Drawing, Descriptive Geometry, Orientation, and Engineering Problems.

It is nice to receive an occasional word of commendation from men outside your immediate field of endeavor. In a recent letter to the editor, Dean G.N. Butler, of the University of Arizona, wrote:

I looked over the contents of your magazine with much interest and approbation. I do not see how a drawing instructor can get along without it.

Professor Paffenbarger and his committee on advanced credits are to be congratulated on doing a fine job and a big job in so short a time.

Professor Street writes:

We have recently had two graduate courses in drawing approved at this institution and they are as follows:

- 601. Advanced Industrial Drawing. (2-2)
Credit 3
- 603. Advanced Machine Drawing. (1-5)
Credit 3

These courses will be given the first term of summer school during 1948 which runs from June 7 to July 17, 1948. They will be repeated from July 19 to August 28, if there is sufficient demand. This makes it possible for people to take a minor in drawing at Texas A. & M. College doing graduate work.

How many of you have requested copies of the tests made available by the Committee on Advanced Credits? If you have not asked for copies to assist in the validation of these tests, you should do so soon. You can receive these tests by writing to:

The Project Office
437 W 59th Street
New York 19, New York

During the past two years, Professor Francis Porter of the University of Illinois has submitted problems, and served as a committee of one in making a selection of the best solutions submitted to the problems, in the Journal under the title of "Solve This One." As Editor, I want to thank Professor Porter for the fine job that he has done.

(Continued from page 6)

It is particularly desirable that there be a good attendance of the younger members in the drawing field. We extend to them a special invitation and hope that you older members will urge the youngsters of your department to attend the convention.

The program arranged by the Drawing Division is a good one and should be of great benefit to us all. We at the University of Texas are grateful for this opportunity to renew old friendships and make new ones, and to return some of the hospitality that has been shown us elsewhere.

TEACHING TOLERANCES

by

J. Gerardi and E.J. Massard
 Department of Engineering Drawing
 University of Detroit

SPECIFICATION OF SURFACE ROUGHNESS

In the preceding articles of this series, methods of limit dimensioning were introduced in an attempt to show what can be taught to freshman and sophomore engineering students. This is the third and final article of this series.

Unfortunately, at present, there is no accepted standard in this country for the designation of surface roughness, particularly with reference to very close limits. While there has been a considerable change in drafting practice since the war, little or nothing has been done as to the specification of the quality of a machined surface. As a result, various manufacturers of machinery and equipment have adopted their own standards. Since the manufacturers are not using the same nomenclature for surface finish, confusion and misunderstanding exists. It is the purpose of this paper to present the trend in specifying surface limitations on drawings.

It has been found desirable to specify the required finish of critical surfaces on detail drawings in at least one of three ways.

1. A general note in the lower right-hand corner of the drawing.
2. In the bill of material.
3. Along the edge view of the surface which is to be finished.

Before we can visualize the importance of surface specification, it is necessary that we have a clear understanding of the fundamental terms.

Surface Quality or surface roughness is the term used to designate characteristics of surface.

Nominal Surface is a two dimensional surface separated from a smooth shape from the surrounding medium. For example: The optional flat is the nearest approach to its nominal surface since it can be made to approach a plane so closely that departures from it are not measurable by any means known at the present time.

Surface Deviation is the departure of the actual surface of an object from the nominal surface of that object. For example: roughness, waviness, and surface flaws are surface deviations.

Surface Flaw is the irregularity of any sort which occurs at only one place or at relatively frequent and widely varying random intervals in a surface. A surface flaw may be a scratch, a ridge, a hole, a peak, or a crack.

Waviness is a surface deviation which consists of irregularities in the form of a wave. On smooth machine surfaces, the length between each wave is ordinarily between .04 and .10 inches and the height of the waves is generally between .002 and .005 inches. Waviness can be measured by conventional dial indicators.

Roughness is the recurrence of irregularities in a surface ranging from .0002 to .010 inches between crests and from .005 to .010 inches in height.

Microinch is one millionth (.000001) part of the U.S. standard linear inch. The microinch is a unit of length convenient and appropriate to many measurements of roughness on "smooth machine surfaces."

Theoretical Root Mean Square (R.M.S.) is the square root of the sum of the squares of the values being averaged, divided by the total number of values. For example, in Figure I the root mean square value of the ordinates of the curve shown would be calculated as follows:

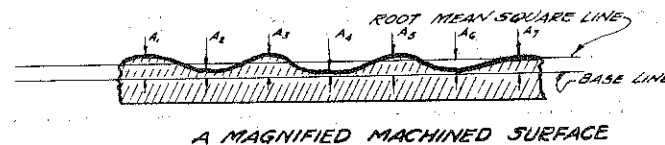

$$R.M.S. = \frac{\sqrt{A_1^2 + A_2^2 + A_3^2 + \dots + A_N^2}}{N}$$

Figure I

Since it is impossible, at the present time, to measure the ordinates on a smooth surface, a profilometer is used to determine an average value of each root and crest in a wave. A profilometer is a very sensitive instrument containing a small diamond point detector. This detector is connected to a receiving unit which measures small changes in current, produced by the irregularities in the surface. A dial calibrated in microinches records the approximate root mean square value of the ordinates.

(Continued on page 32)

Keeping abreast of the latest advances in engineering drawing

THE career of French's *Engineering Drawing* has made textbook history. Since 1911 this classic text has held first place on the drawing boards of hundreds of thousands of students in colleges, universities, and technical schools throughout this country and abroad.

In literary style, logical arrangement, and general teachability, it has been preeminent for over three decades. Each edition has raised the standard of excellence set by previous editions and the present revision again keeps the text abreast of the very latest advances in engineering drawing.

This new edition adds several new chapters, many new illustrations, and a large number of problems reflecting present-day practice. A considerable amount of the old material has been revised, drawings have been changed where necessary to eliminate duplications and ambiguities, and the fundamental chapters I to X have all been revised to improve the order and to achieve clearer, more logical explanations.

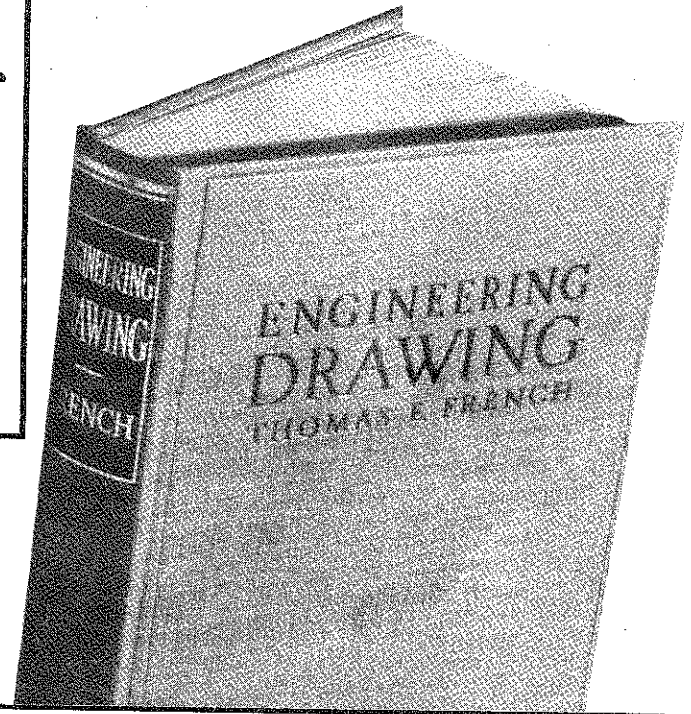

Seventh Edition

ENGINEERING DRAWING

By THOMAS E. FRENCH, Late Professor of Engineering Drawing, The Ohio State University. Revised by CHARLES J' VIERCK, Professor of Engineering Drawing, The Ohio State University. 702 pages, 6x9, 1229 illustrations. \$3.75

3 indispensable aids to accompany French's ENGINEERING DRAWING

ENGINEERING DRAWING SHEETS — SERIES F

Keyed to the New 7th Edition
of French's ENGINEERING DRAWING

By THOMAS E. FRENCH; and H. M. McCULLY, Late Professor and Head of the Department of Drawing and Descriptive Geometry, Carnegie Institute of Technology. \$4.00

These sheets are designed to make the most economical use of time allowed for drawing courses. The careful arrangement of lesson sequence; the time-saving layouts of problems in projections; sections, dimensioning, lettering, working drawings, combine to make a course that compels student interest.

Intended to encourage thorough study of the text, it gives the student a comprehensive view of his subject, leading him to regard drawing as a broad and expressive language rather than a series of monotonous, manipulative details. These study sheets require the student to interpret a drawing from several points of view other than those from which the illustrations are drawn.

The sheets are printed on specially prepared paper in a carefully designed format. They constantly emphasize style and quality to every student.

PROBLEMS IN ENGINEERING DRAWING Series 2

Keyed to the New 7th Edition
of French's ENGINEERING DRAWING

By A. S. LEVENS, University of California, and A. E. EDSTROM, University of California. \$3.00

The new series of this well-known and widely-liked workbook is keyed to the 7th edition of French's *Engineering Drawing*, and has been carefully revised and enlarged from 62 to 72 worksheets.

The Workbook includes a special 48-page supplement, *American Standard Drawings and Drafting Room Practice*, reprinted by permission of the American Society of Mechanical Engineers.

Attention is given to the construction of pictorial drawings directly from orthogonal

views. Problems involving the use of "exploded views" have also been added, making the workbook more effective as a teaching tool, in view of the industrial use of "production illustration."

QUIZ QUESTIONS TO ACCOMPANY THE 7TH EDITION OF FRENCH'S ENGINEERING DRAWING

By JOHN M. RUSS, Professor of Engineering Drawing, The State University of Iowa. 50¢

A new edition of a particularly helpful teaching aid for use with the new edition of *Engineering Drawing*. These questions can be assigned students at various intervals and will be found a great convenience to the instructor as a source of quiz and lecture. The pattern of the previous edition has been followed but improvements in the rearrangement of the material have been made throughout.

4 helpful books to aid in the teaching of engineering drawing

TECHNICAL DESCRIPTIVE GEOMETRY

By B. LEIGHTON WELLMAN, Professor of Mechanical Engineering, Head of Division of Engineering Drawing, Worcester Polytechnic Institute. In press.

The purpose of this book is to provide students with a complete up-to-date treatment of the subject. Written in simple language, the book covers the most elementary concepts and progresses by easy stages to the complex intersection and development problems found in modern applications. Liberal use of clear and effective illustrations supplemented by thorough discussion is an important feature of the book.

GEOMETRY OF ENGINEERING DRAWING

By GEORGE J. HOOD, Professor of Engineering Drawing, University of Kansas. Third edition, 362 pages. \$3.00

The pioneer text in introducing the direct method of teaching descriptive geometry. Adopts the methods, vocabulary and attitude of mind used by the engineer when he visualizes and designs structures. This three-dimensional visualization eliminates the piecemeal consideration of an object in terms of separate, two-dimensional views and projections. The material represents a basic student aid for understanding the subject, and should expedite his progress considerably.

APPLIED DESCRIPTIVE GEOMETRY

By FRANK M. WARNER, University of Washington. Third edition, 252 pages, 5½×8½. \$2.75

This text has been highly successful with teachers because it is easy to teach and understand. It presents descriptive geometry from the point of view of practical drafting-room use, emphasizes the direct view method, and includes a wealth of illustrative problems covering all branches of engineering.

APPLIED DESCRIPTIVE GEOMETRY PROBLEM BOOK

By FRANK M. WARNER and C. DOUGLASS, Department of General Engineering, University of Washington. 54 pages. \$2.50

This problem book furnishes a complete and logical outline with problems for a course in descriptive geometry based on Warner's text described above. It suggests the most valuable problems to use at a place in the outline when the student is able to handle them. The large variety of problems gives a student experience in all branches of engineering.

Send for copies of these books on approval

Seeing around a problem with . . .

GETTING the student to visualize three dimensions successfully has long been a teaching problem in Engineering Drawing. Now, McGraw-Hill offers a series of Text-Films — a new program of visual aids — to help solve this difficulty, and to increase the effectiveness of both teaching and learning.

Seven 16mm. sound motion pictures and six silent follow-up filmstrips make up the complete series, correlated directly with the new 7th edition of French's *Engineering Drawing*.

To illustrate three-dimensional concepts, special models were constructed and photographed in combination with animated drawings of lines and planes. The resulting images on the screen demonstrate clearly and simply principles of orthographic projection, auxiliary views, sectioning, and dimensioning. Filmstrips continue the instruction, and present questions superimposed on still pictures taken from the motion pictures for class review and discussion.

**McGRAW-HILL
TEXT-FILMS**

*correlated with French's
ENGINEERING DRAWING*

MOTION PICTURE TITLES

*(Engineering Drawing Series
16mm. Sound)*

1. According to Plan — An Introduction to Engineering Drawing
2. Orthographic Projection
3. Auxiliary Views — Single Auxiliaries
4. Auxiliary Views — Double Auxiliaries
5. Sections and Conventions
6. The Drawings and the Shop
7. Selection of Dimensions

Write for further information

McGRAW-HILL BOOK CO., INC.

Text-Film Department

330 West 42nd Street, New York 18, N. Y.

PROBLEM SOLUTION

by

Melvin Hainey
University of Texas

PROBLEM: Given any two non-parallel, non-intersecting lines, AB and CD. To construct a line MN terminating in them, and making specified angles α and ϕ respectively with them.

ANALYSIS: The required line or lines will be parallel to the common elements of two right circular cones set up according to the following conditions: 1) the cones have a common vertex; 2) the axis of one cone is parallel to AB and its elements make the required angle with AB; 3) the axis of the other cone is parallel to CD and its elements make the required angle with CD.

CONSTRUCTION: Pass plane 12C through CD parallel to AB and obtain a normal view of this plane. In the normal view, the cones may be set up with their common vertex at any arbitrary point, such as B, and with equal slant heights. Draw lines connecting the common vertex to

the points where the bases of the cones intersect. These lines are elements common to both cones and have the required directions for the solutions. The actual connecting lines may be obtained from an adjacent view which is an end view of either one of the lines, AB in this case.

DISCUSSION: The drawing shows only one nappe of each cone, and the angles α and ϕ are such that two solutions, MN and M'N', are obtained. However, if one or both of the angles were greater, both nappes of the cones should be drawn, and a nappe of one cone might intersect both nappes of the other cone, which would give four solutions. If both α and ϕ are 90° , there will be one solution, the common perpendicular; and the cone method would not be indicated. Obviously, if the angles α and ϕ are such that the cones do not intersect, there is no solution.

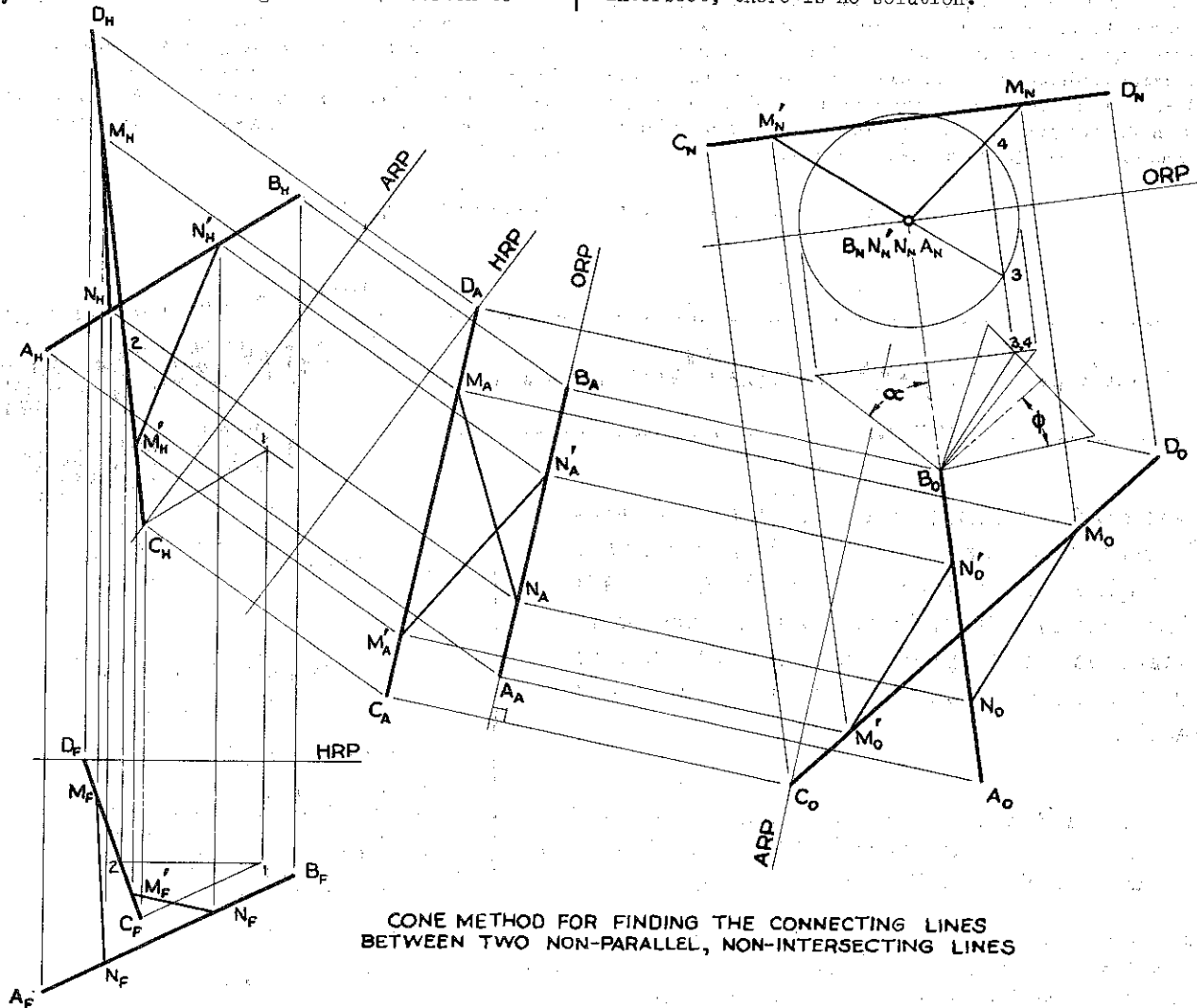

CONE METHOD FOR FINDING THE CONNECTING LINES
BETWEEN TWO NON-PARALLEL, NON-INTERSECTING LINES

THE NEWEST THING IN LETTERING

by

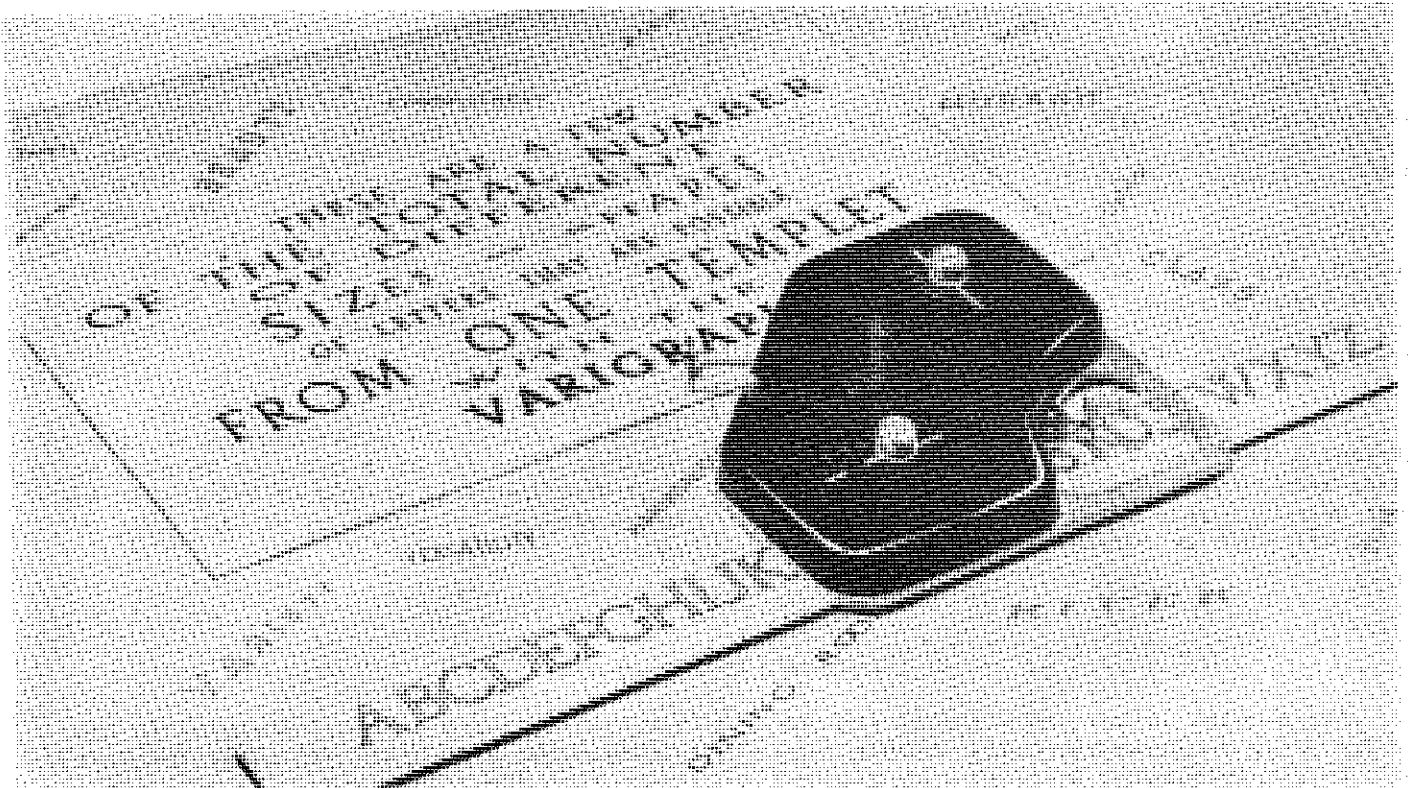
Francis W. Chamberlain and C. Ray Waddle
Lincoln, Nebraska*All that time is lost which might be better employed.--Rousseau*

The rapidly increasing tempo of modern industrial life accentuates the truth of this epigram. On today's drafting board, be it engineers', architects', cartographers', advertising artists' or others', more time is lost in that interminable task of executing acceptable lettering than in the phases of design and detail.

To minimize this profligate use of time, an amazing lettering from one templet has been perfected thru several years of development. With this instrument the lettering artist can easily do ten hours hand lettering in one, and a lettering novice can produce professional results almost as quickly. Its extreme functional simplicity makes it possible for anyone to letter expertly in many alphabet styles from the very first.

The outstanding feature of this device is the heretofore unknown combination of mechanical movements which makes it possible for the operator to reproduce a templet character at infinitely variable ratios of

height to width. Cylindrically concave and cylindrically convex mirrors of various radii alter the reflected image in a similar fashion.

Referring to the accompanying half scale photograph:

The Varigraph Lettering Instrument is a small and compact mechanical instrument which rests on the work to be lettered and it moved from left to right along any straight-edge. A Varigraph Lettering Templet is held under spring tension by the instrument between fixed guideways, which maintain templet alignment at all times. The engraved letter grooves in the templet are followed directly by a thumb and finger controlled stylus. Diagonally opposite the stylus the letter is reproduced at the end of the lettering arm which is raised and lowered by a finger tip controlled lever. Two scale indicating knobs are separately positionable to govern the height and width of the reproduced letter.

(Continued on page 20)

HEAR YE! HEAR YE!

by

John M. Russ
 Professor of Engineering Drawing
 State University of Iowa

It has just come to my attention that some of the plastics now used as material for drawing equipment, have the capacity for utterly destroying organic materials stored in their immediate vicinity.

Recent experience with one of these materials indicated that it had liberated fumes. These fumes attacked some adjacent drawings and records. This situation is caused by improper stabilization.

Professor Ned L. Ashton of the Civil Engineering Department at the University of Iowa, has just discovered the total loss of some very valuable inked tracings. They could not even be picked up out of the drawer.

There is absolutely no question about the cause of their destruction.

Evidence indicates that some of our students' drawing instruments have been corroded after being kept in the same locker drawer with triangles and curves made out of these materials. This in spite of the fact that they were used and aired on the drawing board two or three times a week depending on class schedules.

This matter is of serious import. I think we should all know about it as soon as possible. So far as I know, or am able to find out, there is no way of telling in advance whether a plastic is of this type or not.

(Continued from page 19)

The templet letter being traced and the letter being produced are fully visible, as well as all previously lettered work making it impossible to smear the previously lettered work. Size changes are effected in a matter of seconds by turning the height knob or the width knob until the height and width desired are indicated on the respective scales. These scales are graduated in thousandths of an inch from one hundred and fifty to seven hundred and fifty. Lettering from one hundred and fifty to seven hundred and fifty thousandths of an inch in height or width can be made from a full size templet and lettering from seventy five to three hundred and seventy five thousandths of an inch in height or width can be made from a half size templet. Templet and instrument need not be moved to effect changes in height or width of reproduced letter. There are no adjustments of any kind to make at any time in the use of the instrument. This instrument is unique in that it can be used with equal ease by both the right and left handed person. For left handed operation rotate the

instrument ninety degrees clockwise in the accompanying photograph and slide the templet under from the edge nearest the operator.

It is virtually impossible for a lettering artist to harmoniously proportion all the elements of the letters on work comprising varying ratios of letter widths and heights. These subtle variations in the elements of the letters are difficult to construct especially where the ratio of letter width to height varies from line to line on the same drawing. The Varigraph Lettering Instrument automatically effects the correct relationship of all letter elements in all combinations of letter height and width. It is truly an amazing instrument and something entirely new in mechanical lettering.

Lettering Templet Styles available include all the standard alphabets and many modern alphabets used today by the engineer, architect, cartographer and advertising display artist.

(Continued from page 9)

In order to transform the spherical projection, consisting of array of points described on page 9, to a plane projection, a second operation is performed. The paper plane is first placed tangent to the unit sphere at the north pole. To obtain the "gnomonic" projection, lines are passed from the center of the sphere through the points of the spherical projection and continued until they intersect the tangent plane, to determine new points, such as p_g . To obtain the "stereographic" projection, lines are passed, not through the center of the sphere, but through the south pole, through the points of the spherical projection, and continued until they intersect the tangent plane in points, such as p_{st} .

The complete transformation of a typical crystal, illustrated in Fig. 2, to a spherical

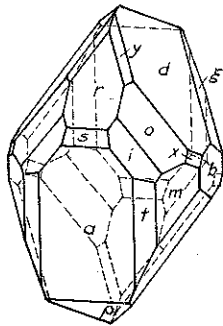

Ferrous sulfate heptahydrate
 $FeSO_4 \cdot 7H_2O$
 Monoclinic

Fig. 2. A typical crystal of the monoclinic symmetry class.

projection is shown in Fig. 3. The subsequent transformation of this projection to the

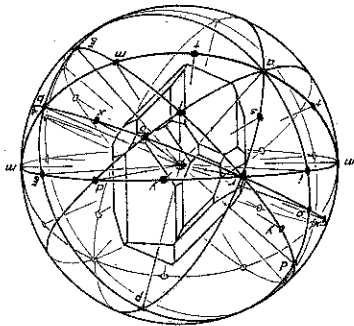

Fig. 3. Formation of the spherical projection of the crystal of Fig. 2.

gnomonic projection is shown in Fig. 4, and to the stereographic projection in Fig. 6.

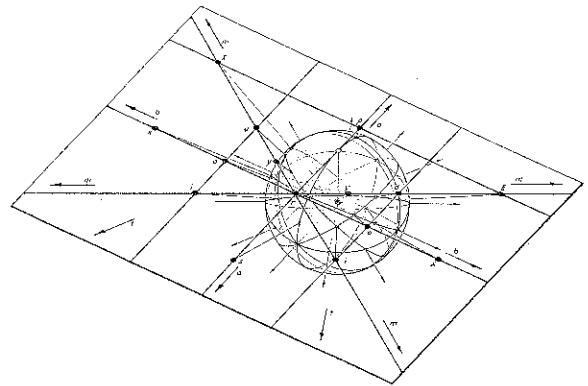

Fig. 4. Formation of the gnomonic projection from the spherical projection.

The true shapes of these projections are then shown in Figs. 5 and 7 respectively. These

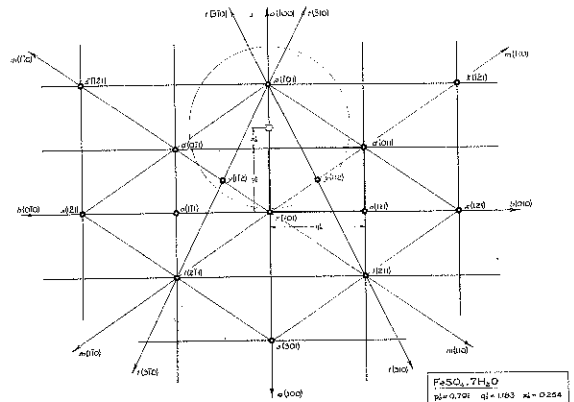

Fig. 5. The gnomonic projection showing the projection lattice and its unit cell. Note: the numbers are the "Miller symbols" of the faces (hkl). h/l and k/l are the plane coordinates of the face poles in terms of the chosen lattice.

figures should aid in the understanding of the discussion of these projections which follow.

The gnomonic projection gives us an array of points on a plane, each of which represents a crystal face and may be called a "face pole". The coordinates of each pole may be easily measured on this plane by a system of polar coordinates centered on the point of tangency, called the "center of projection". These coordinates are readily expressed in terms of ϕ and p :

$$\theta = \phi \quad r = R \tan p$$

where R is the scale of the projection (radius of the sphere of projection). This

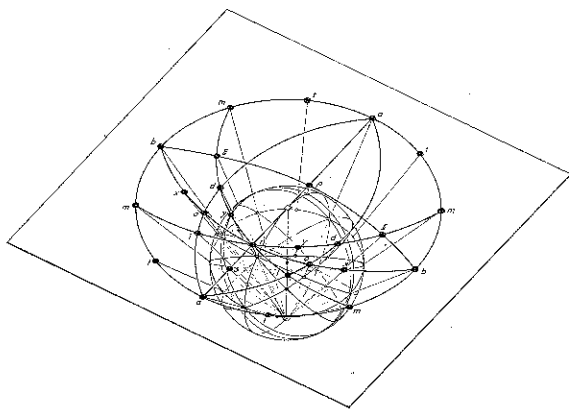

Fig. 6. Formation of the stereographic projection from the spherical projection.

projection has many interesting properties which strikingly express certain important properties of crystals. First, great circles

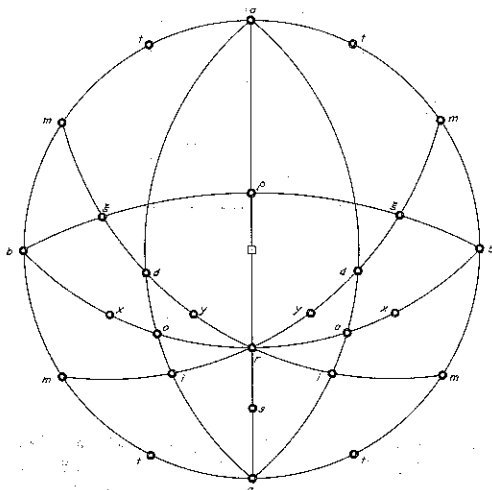

Fig. 7. The stereographic projection.

on the spherical projection become straight lines on the gnomonic projection. Thus, if a series of faces have their spherical poles on the same great circle, their gnomonic poles will all lie along a straight line. Such a series of faces, all intersecting on the crystal in parallel edges, has great significance in the study of crystals, and is called a "zone".

A second important property of crystals appears on the gnomonic projection when it is observed that face poles will always lie on the points of a regular lattice which may be superimposed on the projection. Thus, face poles in a zone will frequently appear equally spaced along the zone line. This property is a direct consequence of the Law of Rational Intercepts referred to earlier, but the law

takes on much more meaning when expressed graphically in this way. When a suitable lattice is chosen to express most simply the array of face poles, the fundamental block of the lattice, called the "unit cell", is then established. Every face pole on the projection may be assigned whole number or simple fraction coordinates in terms of this unit cell. By this process, known as "indexing",

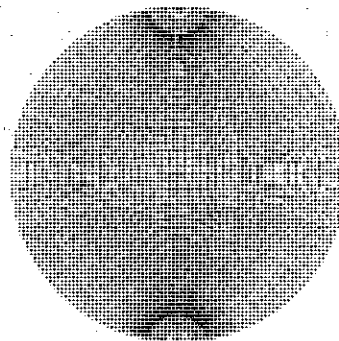

Fig. 8. The stereographic template.

a very compact and eloquent symbol (called the "Miller" symbol) is derived for any face on the crystal. It can be shown that the coordinates obtained in this way are inversely proportional to the axial intercept ratios of the crystal face. The dimensions of the unit cell have values which are characteristic of the substance forming the crystal, and the main purpose of the projection is to obtain these values. They may be read directly off the projection and compared with

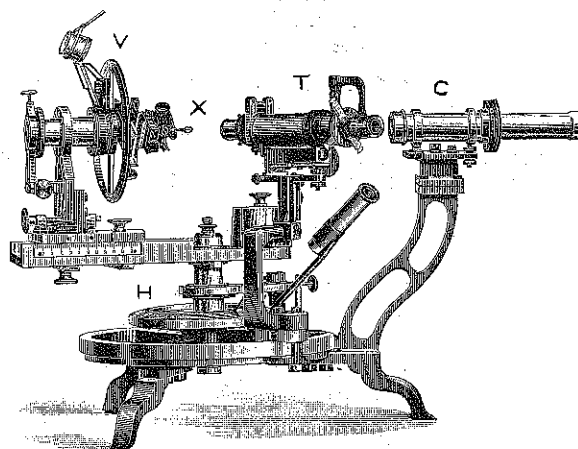

Fig. 9. The two-circle goniometer. C, collimator; H, horizontal circle; T, telescope; V, vertical circle; X, crystal.

values recorded for the same substance in the literature. In the general case, five independent characteristic constants may be measured in this way, but in most cases,

depending on the symmetry of the crystal, two or three are obtained.

A third property of crystals is their symmetry, which we will not have time to consider in detail here, but is really fundamental to the study of crystals. Superficially, we will observe that if one of the symmetry elements is perpendicular to the projection plane, the projection itself will show the symmetry of that element. Thus, if a three-fold rotation axis is present normal to the plane, each face pole must be accompanied by two others equivalent to it at 120° positions around the center of projection. Axes and mirror planes frequently occur in this position, and are an important guide in the proper orientation of the crystal and classification of faces. In Fig. 5, a plane of symmetry is present on edge in a vertical position, so that the right side of the projection is the mirror image of the left side. The symmetry elements allow the faces of the crystal to be divided into groups; each group is designated by a letter, so that each letter represents a certain face on the crystal, and in addition, all the other faces present symmetrically equivalent to it. These symmetry properties

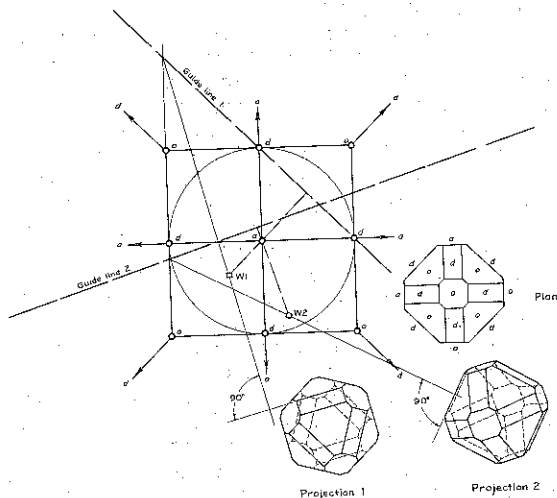

Fig. 10. Gnomonic projection and drawings of crystal of isometric symmetry class.

are illustrated for various cases by Figs. 5, 10, 12, 13 and 14.

The gnomonic projection has one great disadvantage, and that is that vertical faces on the crystal ("prism" faces) project at infinity. These faces we know have $p = 90^\circ$, so that an arrow to indicate ϕ is sufficient; but very steep faces with p ranging from 75° to 90° are difficult to represent properly on the projection

The stereographic projection also consists of point face poles, but this array has

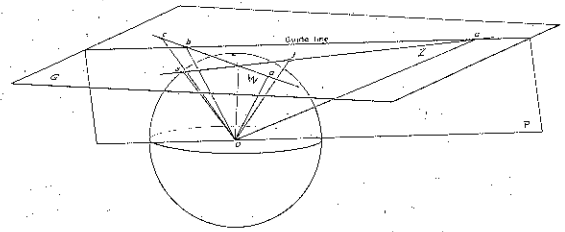

Fig. 11. Proof of Goldschmidt's method of crystal drawing (See text).

an entirely different appearance from that of the gnomonic projection. Zones project as true circles on the stereographic projection, and thus are prominently displayed. Since spherical poles are projected along lines originating at the south pole of the sphere,

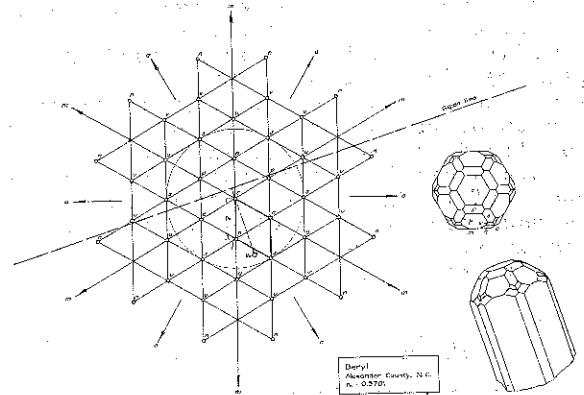

Fig. 12. Gnomonic projection and drawing of crystal of hexagonal symmetry class.

the equator projects as a finite circle (the prism zone), and all faces down to 90° are conveniently projected. But the lattice aspect of the face poles is completely lost in this projection, and this is its greatest drawback.

An interesting property of the stereographic projection is that not only great circles, but also small circles on the sphere of projection appear as true circles on the tangent plane. This gives rise to three convenient applications, as follows:

- (1) Dihedral angles on the crystal (interfacial angles), corresponding to great circle angles between face poles on the spherical projection, are conveniently measured on the stereographic projection.
- (2) The locus of face poles equidistant from a given face pole projects as a true circle on the stereographic projection. Thus, if it is known that an unknown face has an

interfacial angle 22° from plotted face A and an angle of 38° from plotted face B, these two loci are readily drawn with a compass on the stereographic projection, and the unknown face plotted at the intersection.

- (3) If it is desired to rotate the crystal to a new position, the face poles are easily followed in this operation on the stereographic projection, since they move in circles. The gnomonic projection is entirely unsuited for this purpose, since the poles move in hyperbolae. The face poles may be plotted on a stereographic projection using polar coordinates by the transformation:

$$\theta = \phi \quad r = 2R \tan \frac{\phi}{2}$$

To plot faces, and to perform the operations described above, it is convenient to use a template on which the transformed angles are permanently graduated. The most convenient template is one shown in Fig. 8, in which a system of great circles is projected intersecting in a horizontal axis, and a system of small circles projected normal to the same axis. The crystal projection can then be made easily on tracing paper over the template, arranged to rotate freely about a pin at the center.

PROCEDURE FOR CRYSTAL MEASUREMENT

It appears, then, that suitable combination of these two projections in the process of analyzing a crystal will satisfy all the needs of the crystallographer. We may now follow a typical morphological analysis of a crystal, to see how they are applied.

The first practical problem is the measurement of the crystal. The classical instrument for this purpose is the simple contact goniometer (arm and protractor), used by Haüy, and still used today for large, hand sized crystals. This device measures, with say $\pm \frac{1}{2}^\circ$ accuracy, the dihedral angles between the faces of the crystal. A refinement of the method was developed in the one-circle goniometer, which is adapted to the measurement of much smaller crystals with an accuracy of $\pm \frac{1}{2}$ minute of arc. It consists of a horizontal graduated circle on which the crystal is mounted and rotated. A collimator and telescope are fixed to the stand supporting the rotating circle, with their horizontal optic axes intersecting the vertical axis of the circle. The observer sees a signal formed by a reticle in the collimator when a crystal face, acting as a plane mirror, is in position to reflect it into the telescope. To measure the angle between two faces, it is necessary to orient the crystal so that both faces are vertical. Each face is then brought into

reflecting position, and the angles read on the graduated circle at these positions provide by their difference the dihedral angle. To measure other dihedral angles, the crystal must be reoriented for each zone.

More useful data are obtained by use of the two-circle goniometer shown in Fig. 9. This instrument is based on the one-circle goniometer, but a second, vertical, graduated circle is mounted on the horizontal one, so that the crystal, attached to the vertical circle, lies at the intersection of the two circle axes, and the optic axes of the collimator and telescope. The two circles now correspond to the two spherical angles ϕ and p . By proper adjustment of the two circles, any face on one hemisphere of the crystal may be brought into reflecting position, without remounting the crystal. When a face is in this position, its angle of inclination (p) may be read directly on the horizontal circle, and the angle of azimuth (ϕ) on the vertical circle. With this instrument, a crystal as small as $1/20$ millimeter may be precisely and completely measured in one setting.

The next step in the process is the plotting of the stereographic projection of the crystal from the data obtained with these instruments. Where dihedral angles only are available, as obtained from the one-circle goniometer, the projection must be constructed by laying out spherical triangles on the template by the use of circle loci, until all the zones are located. Where spherical angles are available, as obtained from the two-circle goniometer, they may be plotted directly by use of the transformation formulae suggested above, or better by use of the template. This projection may now be rotated in various ways until it is brought into a standard position with respect to symmetry and well-established conventions. If this orientation is known beforehand, the crystal can be set up on the two-circle goniometer so that the resulting projection will automatically have the right orientation. In this case, the face poles may be plotted immediately on a gnomonic projection without using a stereographic projection. Fortunately, this is the common circumstance. But when it is not, the stereographic projection is used to achieve the correct orientation; when this is done, the reoriented face poles are then transferred to a gnomonic projection.

In any case, a gnomonic projection of the crystal in its proper orientation is obtained by one route or another. On this plot, the basic lattice on which the face poles lie is usually obvious. The choice of lattice is always somewhat ambiguous, since there are always two or three possible unit cells, among which it is impossible to choose, except arbitrarily. As we have seen, the lattice dimensions, measured directly on this projection, are characteristic of the substance

(Continued on page 26)

A NON-CREDIT COURSE IN DRAWING IN LIEU OF HIGH SCHOOL DRAWING FOR STUDENTS DEFICIENT IN HIGH SCHOOL DRAWING

by
Robert R. Irwin

Assistant Professor of Mechanical Engineering, Oklahoma A & M College, Stillwater, Oklahoma

Fortunately or unfortunately, not all students enter a college of engineering with the same background. In the same vein, not all graduates attain the same level of training and knowledge. Between the minimum and maximum levels stands the engineering instructor with his pencil poised to outline a course of study for Engineering Drawing. Which level do you choose? Sitting on the fence merely makes you the target for both sides. On one side the student who does not know what a T-square looks like, on the other, a student with four years of high school training.

A survey of students enrolled at present in the School of Engineering at Oklahoma A & M College disclosed that 60% had not taken a drawing course in high school, 18% had taken a single semester of drawing, and 22% had more than one semester high school training in drawing.

Approximately 25% of Oklahoma high schools offer courses in drawing. Of course, most of the larger schools that furnish the largest percentage of students for the Engineering college offer several courses in drawing. It is probable that over half of the engineering students have an opportunity to take drawing in high school.

May I describe the situation of the basic Engineering Drawing course in the Engineering college. With variations, the situation at Oklahoma A & M College is much the same as at most other engineering schools. A two credit hour course in basic engineering drawing is offered and required of all engineering students except those enrolled in the School of Architecture. There are no prerequisites for the course. An advanced machine drawing course is required of students in the Department of Mechanical Engineering. This means that the majority of students receive their only training in drafting from courses in Engineering Drawing and Descriptive Geometry.

The objective and traditional purpose of these courses is to give the student the ability to use and understand the language, drawing. Courses in the oral and written language are utilized throughout a student's formal education. Even the most hopeless appearing freshman can write home for money. Consider the contrasting background of engineering students in the two languages.

My purpose today is to urge more adequate background for students in the language of drawing. I agree most heartily with Professor John Rule's statement in this article Graphics Re-Examined. "It is difficult to visualize how lost the engineer would be if he had no acquaintance whatever with the drawing board." This acquaintance must be started earlier than is now the general practice if the first year courses in graphics are to make possible, the "ultimate stature of Scientific and Engineering Graphics" envisioned for them by men who have contributed so much to their present stature. The logical place to start this earlier acquaintanceship is in the high school by requiring 1 credit or $\frac{1}{2}$ unit of drawing as a college entrance requirement.

From the previous discussion it is apparent that regardless of how worthwhile the objective of requiring drawing in high school, the engineering college will have to help solve the problem. A non-credit course could be set up that would enable entering students without high school credit to meet the entrance requirement. Under such a scheme, the prerequisite for the Basic Engineering Drawing course would be the entrance requirement of 1 credit in high school drawing or the elementary drawing course. The immediate benefit of an elementary drawing course to students in Basic Engineering Drawing, is that the student will be able to start his study at a higher level and his progress should allow fuller attainment of the course objectives. A secondary benefit that might prove to be the most important, would be the introduction of drawing as a general educational subject. Certainly in a technological age such as ours, all members of society are beginning to feel the need of a knowledge of the language of drawing.

One objection to requiring the elementary drawing course or its equivalent would be that the time required for graduation might be increased. This objection is not valid however, as only about 25% of graduating students are able to obtain their degree in eight semesters. Of course as the demand for a high school drawing course increases, the number of schools offering such a course will increase and the problem will gradually become one for the high school and not the college.

I feel that it is necessary for the college drawing instructors to cooperate with the schools training high school drawing teachers and with the teachers themselves in order that the entire level of instruction in engineering drawing may be raised. Many high schools do not include drawing because due to various factors they are able to maintain only a minimum level of courses offered. Requiring drawing for college entrance will serve as a device to introduce or increase training in the graphical language.

The elementary drawing course should stress the fundamentals of drawing and leave to the Basic Engineering Drawing course the problem of composing working drawings. The subjects that should be stressed in such a course are as follows:

- Proper use of instruments and materials.
- The geometry of engineering drawing
- Projection.
- Sectioning.
- Introduction to dimensioning.
- Introduction to fasteners.

Naturally there will be as many different groupings of the above list as there are people discussing the idea. The suggested time allowed for such a course would be the equivalent of one semester credit hour, or three hours of class work each week. This amount of time would probably be adequate to give a course equivalent to a single semester of high school work.

A REPORT OF THE VISUAL AIDS COMMITTEE

by

H.B. Howe, Chairman
Rensselaer Polytechnic Institute
Troy, New York

The aims of the committee:

- (1) To survey the various visual aid methods. (the committee decided to limit its survey at this time to film, film strip and slides.)
- (2) To publicize a summary of the survey.
- (3) To investigate and promote further development of effective visual aid methods.

The committee mailed 335 questionnaires and received 156 replies, with 44 answers indicating visual aid users. The accompanying map shows the distribution of the above information.

Comments and inquiries indicate membership consciousness of the impetus this type of teaching aid gives to a fuller inspirational lift and understanding of fundamental and related subject matter. However, it is obvious that with the list of films available (table #3), the finding of this survey does not impart a finished picture of the aids now in use. We apparently have not contacted all of our members who use them. In order to give a truer picture we ask each additional, present or new user of visual aids to send information that we may make our survey more complete.

The committee appreciated the cooperation of the members in conducting this survey.

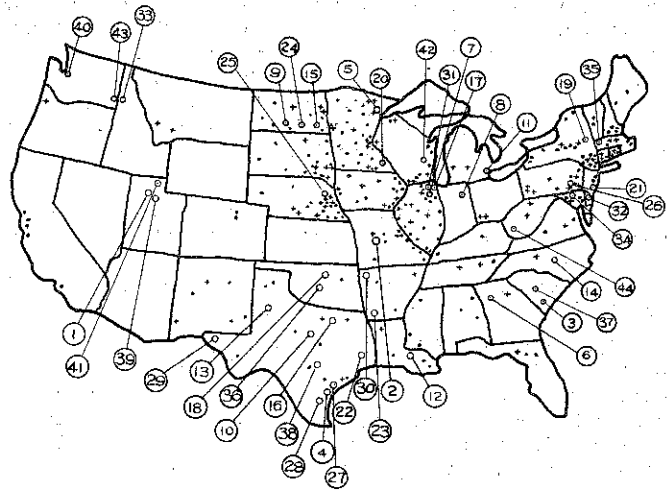

VISUAL AID SURVEY
Distribution Map

Key:

- Questionnaire
- + reply received
- visual aids user
- ⑫ school no. (see table #2)

Visual Aids Committee

H.B. Howe, General Chairman
J.B. McGuire
H.L. Minkler
L.G. Palmer
J.S. Rising
Justus Rising
C.L. Tutt, Jr.
F.M. Warner

Rensselaer Polytechnic Institute
A & M College of Texas
Illinois Institute of Technology
University of Minnesota
Syracuse University
Purdue University
General Motors Institute
University of Washington

(Continued from page 24)

forming the crystal, and may be used to identify that substance. In the case of minerals, the lattice constants of all species have been tabulated in complete form, and an unknown crystal may usually be identified by comparing the graphically determined constants with

these tables. These lattice constants are identical, incidentally, with those determined unambiguously by X-ray diffraction methods.

Both the stereographic and gnomonic projections may be used to determine readily
(Continued on page 28)

Quality....



DRAWING MATERIALS

DRAWING INSTRUMENTS
IN SETS

DRAWING AND
TRACING PAPERS

WATERPROOF
DRAWING INKS

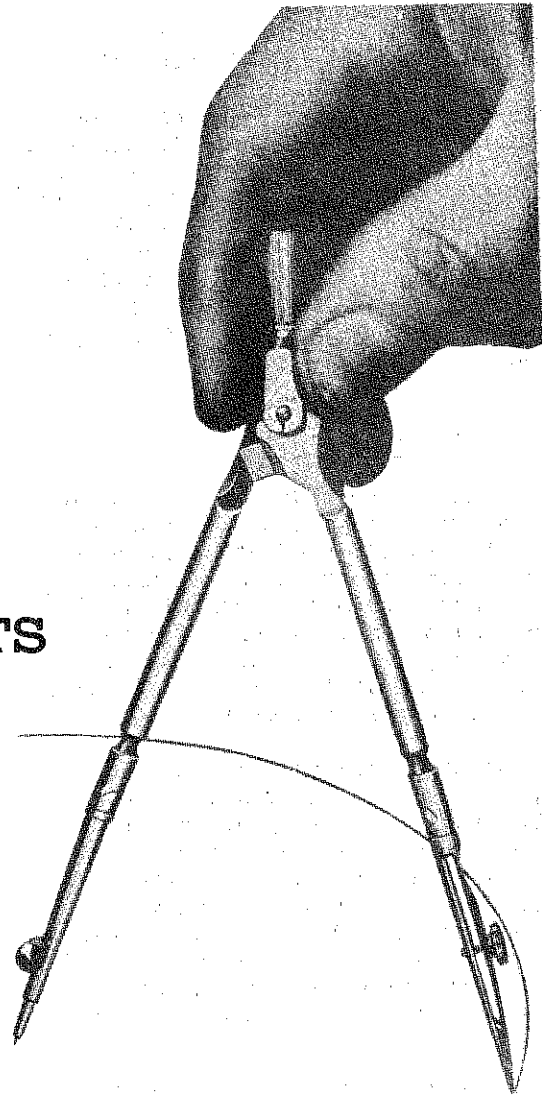

STUDIO, SCHOOL AND
DRAFTING ROOM FURNITURE

Catalogue, Vol. 700, on Request

F. WEBER CO.

FACTORY ADDRESS:
1220 BUTTONWOOD STREET
PHILADELPHIA, PA.

Branches:

705 PINE ST., ST. LOUIS, MO.
227 PARK AVE., BALTIMORE, MD.

(Continued from page 26)

interfacial and interzonal angles, and the geometry of any other vectorial properties of the crystal (e.g. optical properties). These measurements may be refined by mathematical and statistical analysis of the original data if desired. It is a curious fact, however, that the average deviation of carefully made goniometer measurements (seldom as good as 0.1%), with rare exceptions far exceeds the magnitude of accuracy ordinarily claimed for lattice measurements (0.01%). Crystals are never perfect creations, except by the crudest standards.

CRYSTAL DRAWING

Finally, in our procedure of morphological analysis, we find that drawings of the crystal in orthographic projection along any desired projection direction may be made directly and easily from the gnomonic projection. Goldschmidt's method for doing this, illustrated in Fig. 10, is ingenious and striking. Let us first follow the procedure itself; it is simply stated as follows:

- (1) An orthographic projection plane (picture plane) is passed through the center of the sphere of projection, in any desired orientation. It is identified by its trace on the gnomonic projection plane, a straight line which we shall call the "guide line". The position of this line immediately indicates the orientation of the picture plane.
- (2) The picture plane is rotated into the gnomonic plane about the guide line as an axis. The center of the sphere is readily found in its rotated position, and this point is called the "angle point".
- (3) If two faces intersect on the crystal, their face poles are joined by a straight zone line, which is extended until it intersects the guide line.
- (4) The intersection point found in step (3) is joined by a straight line with the angle point. The direction of the line into which the edge between the two faces will project on the picture plane is normal to this line.

By this simple process, any desired picture plane may be immediately established, and the edge between any pair of faces on the crystal may be quickly and easily constructed upon it. The shape of the crystal and its faces is determined as the drawing proceeds by reference to another drawing, or better, the original crystal. Thus the third dimension is reintroduced, as it cannot be supplied by the gnomonic projection. When it is desired to draw a crystal in ideal form with respect to its symmetry, many crystallographers find it convenient to draw a plan of the crystal where the axes and planes of symmetry appear on end and on edge. In this case, the picture plane is the gnomonic projection plane, and the crystal edges are simply drawn normal to the corresponding zone lines themselves. In this view, the faces of the crystal can be accurately drawn in their proper size and shape. The usual pictorial orthographic is then drawn on a conventional picture plane with $p = 80^\circ$ and $\phi = 70^\circ$. The proportions are maintained accurately in the pictorial view by direct projection from the plan view. Thus, the pictorial (which, though strictly orthographic, is often called "perspective" by crystallographers) gives an attractive view from a point of view, so to speak, 10° above and 20° to the right of the crystal. As a matter of fact, in the drawing of this pictorial, the operations of symmetry can be followed in this view directly as a guide to the ideal development of faces, so that the plan view is unnecessary, and best omitted.

It would be worthwhile, perhaps, to verify the rather extraordinary construction just described with a simple geometric proof. In Fig. 11, let the face poles s and t on the gnomonic plane G be given, and the picture plane P . All lines and planes will be drawn through the common point O , the center of the projection sphere. The intersection line between the crystal faces represented by vectors Os and Ot will be parallel to line Oc , which is perpendicular to plane Z containing lines Os and Ot . Line Oc will be projected orthographically onto plane P into line Ob by plane W , perpendicular to plane P . In the construction, the zone line st on the gnomonic projection plane G is extended to cut the trace of plane P in plane G (the guide line) at point a . Line Ob is then constructed normal to line Oa (with the plane P rotated into the paper plane G). We would like to show that Ob is truly perpendicular

(Continued on page 30)

TECHNICAL DESCRIPTIVE GEOMETRY PROBLEMS

by

WILLIAM E. STREET

Professor and Head of the Engineering
Drawing Department, Agricultural and
Mechanical College of Texas

CONNER C. PERRYMAN

Professor of Engineering Drawing,
Texas Technological College

JOHN G. MCGUIRE

Professor of Engineering Drawing,
Agricultural and Mechanical Col-
lege of Texas

Published in August, 1947, the problems in this text are organized for use with any suitable text book although designed with a view towards Professor Street's forthcoming book TECHNICAL DESCRIPTIVE GEOMETRY. They have been selected to emphasize descriptive geometry fundamentals applicable to all technical fields. Methods of solution have been painstakingly correlated with industrial drawing methods as set forth in all standard works on Engineering Drawing. It is for the generally accepted freshman course.

CONTENTS

Projections; Primary Auxiliary Views; Successive Auxiliary Views; Revolutions; Developments; Intersections; Perspective; Shades and Shadows; Force Diagrams and Loaded Structures.

79 pages

8½ x 11

Loose Leaf Binding

\$2.50

SEND FOR AN
EXAMINATION COPY

D. VAN NOSTRAND COMPANY, Inc.

1848

One Hundred Years of Publishing

1948

250 FOURTH AVENUE

NEW YORK 3, N. Y.

(Continued from page 28)

to Oa . Plane W will contain line Oc , normal to plane Z , and line Od , normal to plane P . Since line Oa lies in both planes Z and P , it will be perpendicular to both lines Oc and Od , and therefore, perpendicular to plane W . Therefore, line Oa will be perpendicular to line Ob , which lies in plane W .

Drawings can also be made very conveniently directly from the stereographic projection. Fig. 13 shows an example illustrating the method, which is similar in

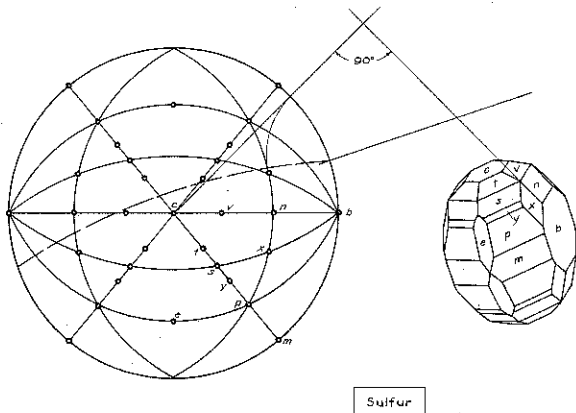

Fig. 13. Stereographic projection and drawing of crystal of orthorhombic symmetry class.

principle to that used with the gnomonic projection. The picture plane is first established in any desired position by drawing the projected great circle in which it cuts the projection sphere (long-dashed circle in the figure). The zone circle between two poles, such as x and n , is extended to cut the picture plane circle. This point of intersection determines a line with the center of the sphere which corresponds to line aO in Fig. 11, and is perpendicular to the desired projected crystal edge between faces x and n . The picture plane is now rotated into the paper plane about a horizontal axis, and the normal constructed to the radial line as shown.

Crystals often grow in pairs called twins, in which one individual is related to

the other so that it is the mirror image of the other over a possible crystal face as a twin plane. Fig. 14 shows such a twin with its stereographic projection. The faces of

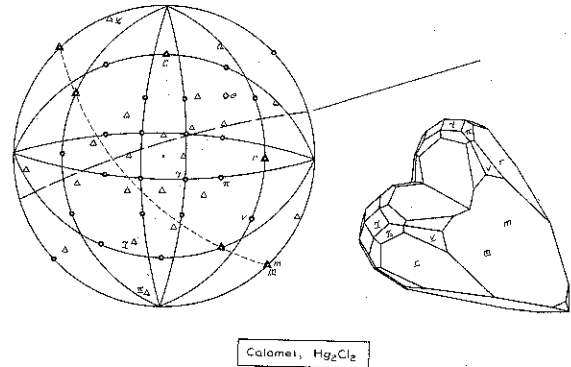
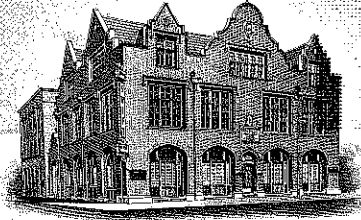

Fig. 14. Stereographic projection and drawing of twin crystal of tetragonal symmetry class.

the upright individual are projected as circles, the twin plane as a dotted circle with its pole at e , and the faces of the twin individual as triangles. The last are readily constructed from the first, as shown by δ as an example. δ and its twinned counterpart δ' lie in a zone with the twin plane e , and the angle $\delta \wedge \delta'$ is bisected by the twin plane. It is seen, then, that the important phenomenon of twinning of crystals is easily handled quantitatively by projection methods.

Crystal drawing is thus so highly developed that it is possible to make the most complex crystal drawings by routine methods, without regard to theory. In a way, this is fortunate, for it is a curious fact that very few crystallographers are good draftsmen or expert in graphical methods; Goldschmidt's methods enable such workers to carry out drawings by rote. On the other hand, rote methods are dangerous here as in any process, for in the hands of persons who depend on rote they lead to unsuspected errors and inaccuracies which occasionally are rather serious. In the hands of a crystallographer thoroughly familiar with the principles behind the projection methods and also general descriptive geometry and drafting techniques, however, the methods are very powerful, rapid and accurate.



University Engineering Departments

USE THE

JOHN S. SWIFT CO., Inc. PLANOGRAPH PROCESS

FOR THE REPRODUCTION OF

DRAWING SHEETS



PROBLEM BOOKS



MECHANICAL DRAWINGS



MAPS—CHARTS



INSTRUCTION MATERIAL

Your Choice of Binding: LOOSE-LEAF, SEWED AND CASED, WIRE SPIRAL, PLASTIC, ETC.

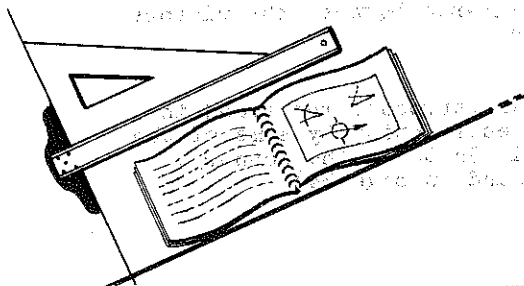

JOHN S. SWIFT CO., Inc.

OPERATING FIVE PLANTS

New York 1, N.Y.
455 West 30th St.
Lackawanna 4-1144

Chicago 7, Ill.
17 N. Loomis St.
MONroe 7020

St. Louis 3, Mo.
2100 Locust St.
CHestnut 7141

Cincinnati 2, O.
3rd and Vine Sts.
PArkway 4148

Cleveland 13, O.
116 St. Clair Ave., N.W.
PProspect 4488

(Continued from page 15)

The American Standards for graphical symbols and abbreviations for use on drawings, has proposed a symbol similar to the square root sign ($\sqrt{\quad}$) to indicate the finish of a surface. The addition of a numerical symbol in the opening of the "v" portion would denote the qualitative value of the roughness permitted, measured in microinches. When specifying the roughness symbol on a surface, one should remember to specify only the surface requiring special accuracy, because of extra cost involved.

The following table has been prepared by the American Standards Association and gives the roughness symbol and the root mean square values of surface irregularities for the most commonly used designations for surface specifications:

Roughness Symbol	Root Mean Square Height of Irregularities (Inches)	Microinches
63M	.063	63000
16M	.16	16000
4M	.004	4000
1M	.001	1000
250	.00025	250
63	.000063	63
32	.000032	32
16	.000016	16
8	.000008	8
4	.000004	4
2	.000002	2
1	.000001	1
$\frac{1}{2}$.0000005	$\frac{1}{2}$
$\frac{1}{4}$.00000025	$\frac{1}{4}$

The surface roughness symbol as specified in the first classification, (62M, 16M, 4M, and 1M), applies to surfaces produced by rough machining, turning, boring, and milling. This group also applies to rough castings that have been thoroughly cleaned of all sand and scale.

The increasing demand for higher output and smaller clearances in the internal combustion engine, necessitates the use of the second group of roughness symbols for critical surfaces. For example: 250, 63, 32, 16, and 8, would be used on surfaces such as pistons, crankshaft bearings, connecting rod bearings, and valve stems. Diamond boring and finish grinding are also included in this series.

The third classification 4, 2, 1, is for very fine finishing operations, finish grinding followed by polishing, and lapping. Current manufacturing processes, at the present time, approach this series.

The fourth classification $\frac{1}{2}$, $\frac{1}{4}$, etc., applies to highly polished finishes used largely in experimental laboratories and on gauges.

Although the American Standards Association has proposed the placing of the roughness symbol on the surface to be controlled, the industries have found it more convenient to specify it in the form of a note. This can be appreciated by the fact that most drawings are very crowded without the addition of roughness symbols on all critical surfaces; furthermore, by placing the surface specification in a note, it is not likely to be overlooked.

Figure II shows a valve and valve guide which illustrates a method of designating surface control without the use of symbols.

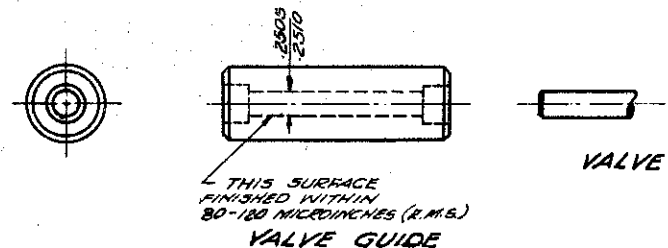

The diameter and a note specifying surface roughness would be shown in a similar manner on the valve.

Figure II

It is interesting to note that the variation of surface finish between 80 and 120 microinches is important in this case to insure lubrication by the proper functioning of the valve and the valve guide. If the two surfaces were held to closer limits, 10 to 50 microinches for example, there would be a pumping action between the valve guide and the valve stem. However, if the two surfaces were permitted to be finished to wider limits of roughness, 150 to 200 microinches, there would be very poor lubrication between the two parts. It is obviously apparent that surface specification is important and necessary in order to produce specific results demanded by industry.

Roughness specifications are also used on the outside diameter of pistons, because of the increase in compression ratio and reduction in the clearance between the pistons and cylinder walls.

These examples represent the trend in surface quality specification by some of the largest industrial plants in the country.

(Continued on page 34)

ENGINEERING DRAWING

By LEON MARR SAHAG, *Professor of Machine Design and Drawing,
Alabama Polytechnic Institute*

MANY years of both teaching and industrial experience have gone into the development of the ideas, methods, and materials of Professor Sahag's book. Stress is placed on accurate reasoning, solving problems unaided and translating theory into practice. Testing it, continually rounding out and refining his material through extensive use in drawing classes, Pro-

fessor Sahag has succeeded in formulating highly efficient teaching methods, and these he has articulated with the current standards and procedures of industrial practice. The result is a text which not only gives the student maximum training in the minimum time, but thoroughly acquaints him with the procedures he will meet in industry. 394 Pages \$3.50

Texts by WILLIAM WIRT TURNER

*Professor and Head of the Department of Engineering Drawing,
University of Notre Dame*

Simplified Perspective

A sound textbook on the theory and practice of perspective drawing. Equips the student to make architectural, mechanical, and production drawings such as the exploded views finding

increasing use in manufacturing. Construction procedures are given on each drawing. Problems are solved in detail. 243 Pages \$5.00

Freehand Sketching for Engineers

Improves the sketching ability of students and engineers, teaches the theory underlying engineering drawing and trains in the reading of drawings. These work sheets are organized to show how to analyze problems, select the proper

views to present the object clearly and completely, relate these views to one another, and annotate and dimension them correctly. Teacher's Manual available. \$2.50

Basic Problems in Engineering Drawing

Revised Edition. A series of work sheets based on third angle projection. It is in keeping with the prevalent trend of coordinating engineering drawing and descriptive geometry courses.

Sheets include work commonly taught during freshman year. Teacher's Manual available. \$2.50

Basic Problems in Descriptive Geometry

(written in collaboration with CARSON P. BUCK)

A series of work sheets based on third angle projection, general in character, and prepared for use with any standard text in descriptive

geometry which employs the direct or auxiliary plane method. Problems are practical in nature. Teacher's Manual available. \$2.00

THE RONALD PRESS COMPANY

15 East 26th Street, New York 10

(Continued from page 32)

The advantages of having a universal set of standards would be:

- (1) The manufacturers and men in the shop have definite methods and easily understood instructions on the drawing as to the finish required.
- (2) Where finer finishes are desired and ordinarily expressed by the symbol f , they may be exactly defined by the roughness symbol to indicate the permissible variation on the finish.
- (3) Samples of finish do not have to be submitted with requisitions.
- (4) This method will prevent rejections because of misunderstandings as to the quality of work ordered.

It is our opinion that the material presented in this series of articles could

be, and should be, taught to students in engineering drawing. We welcome comment from other members of the drawing division.

BIBLIOGRAPHY

Transactions - A.S.M.E. - 1931

"Survey of Surface Quality Standards" ---
Harrison

Mechanical Engineering - November, 1937

"Surface Finish" --- Stewart Way

Mechanical Engineering - March, 1938

"The Profilometer" --- E.J. Abbott and
D.E. Williamson

Heald Machine Company - Detroit, Michigan

SOLVE THIS ONE

Professor Francis Porter of the University of Illinois submits the following problem:

Given any triangle ABC, say with $AB=5"$, $AC=6"$, and $CA=7"$. It is required to construct a pyramid with this triangle as base, and with the lateral edges inclined specified angles to the plane of the base, say 60° , 65° , and 75° , at A, B and C respectively.

This column is designed for the entertainment and improvement of those who enjoy putting Descriptive Geometry to work for the thing it is credited with doing best--training one in clear, logical and constructive

thinking. It is open to contributions of progressive professors pet personal puzzling problems. A year's free subscription to the Journal will be entered for the reader who first submits any problem accepted for publication. A correct solution shall accompany problem offered.

A year's subscription is also presented the reader who submits, in time for publication in the ensuing issue, the best solution. If a drawing is required, one done in ink shall accompany it as copy for reproduction. All constructions must be Euclidean; that is, only straight edge and compass should be used.

REPORT OF THE BIBLIOGRAPHY COMMITTEE

by

Prof. H.H. Fenwick
University of Louisville

NEW AND REVISED BOOKS

Author	Title	Ed.	Publisher	Year	Pages	Prices
Bryant & Dickinson	Jigs and Fixtures for Mass Production	1	Pitman Pub. Co.	'47	222	\$3.50
Giesecke, Mitchell & Spencer	Technical Drawing Problems	Rev.	The MacMillan Co.	'47	105 sheets	2.75
Johnson, A.F.	Applied Descriptive Geometry	1	Students Book Co.	'47	197	2.00
Levens, A.S.	Nomography	1	John Wiley & Sons, Inc.	'48	161	3.00
Levens, A.S. & Edstrom, A.E.	Problems in Engineering Drawing Series 2	1	McGraw-Hill	'47	72 sheets	3.00
Luzadder, W.J.	Fundamentals of Engineering Drawing	Rev.	Prentice-Hall			
McGraw-Hill	Text Films (16mm) Sound & Silent Filmstrip	1	McGraw-Hill	'47	7-films 6-strips	
Plumridge, T.C., Boyd, R.W., McKinney, James J.,	Machine Tool Guide	1	American Technical Society	'47	750	8.00
Rusinoff, S.E.	Practical Descriptive Geometry	1	American Technical Society	'47	259	3.50
Turner, W.W.	Basic Problems in Engineering Drawing	Rev.	The Ronald Press Co.	'47		2.50
Turner, W.W., Buck, C.P.	Basic Problems in Descriptive Geometry	1	The Ronald Press Co.	'47		2.50
Turner, W.W.	Simplified Perspective		The Ronald Press Co.	'47	236	5.00
Exton, Wm., Jr.	Audiovisual Aids to Instruction	1	McGraw-Hill	'47	343	4.00
Sahag, Leon M.	Kinematics of Machines		The Ronald Press Co.	'48	249	4.00

MAGAZINE ARTICLES

Author	Title	Page	Publisher	Page	Month	Year
Hauck, C.J., Jr.	"How Trade-marks, Patents and Copy rights, Protect your property."	221	Petr. Ink	41-6	Dec. 19	'47
Kettler, C.J.	Photo-projection inspection and layout of castings.	160	Iron Age	478	July 31	'47
	Pictures in three dimensions; AkraVue, the second method developed.		Business Week	324	Aug. 30	'47
	Remodeled drafting room; better lighting, air conditioning.	177	Science American	26	July	'47
Rettig, L.C.	Lighting for Drawing Offices	40	Light & Lighting	108-11	June	'47
Rowbotham, G.E.	"Basic standard drafting practice guarantees correct interpretation."	18	Product Eng.	137-140	July	'47
	Stereo viewer has plastic case and light control button.	25	Modern Plastics	119	Dec.	'47
	Trivisions bow; three dimensional photography process scheduled to be unveiled this summer.		Business Week	20	June 21	'47

ENGINEERING DRAWING— PRACTICE AND THEORY

By the late Isaac N. Carter, Associate Professor of Civil Engineering, the University of Idaho; and H. Loren Thompson, formerly Assistant Professor, Northwestern Technological Institute; now partner, Stevens & Koon, Consulting Engineers, Portland, Oregon. Second Edition, 462 pages, 8½ x 11, 869 illustrations, \$3.50.

CONTENTS: Introduction; Lettering; Use and Care of Drawing Equipment; Geometrical Elements of Structures; Theory of Drawing; Principal Views; Section Drawing; Auxiliary Views; Revolution; Dimensioning; Fasteners; Point, Line, and Plane Problems; Surfaces, Intersections, and Developments; Pictorial Drawing; Working Drawings; Machine Elements; Welding Drawing; Pipe and Fittings; Sketching; Perspective Drawing; Architectural Drawing; Structural Drawing; Reproduction of Drawings; Appendix; Index.

DESCRIPTIVE GEOMETRY FOR ENGINEERS

By the late Harry C. Bradley, Professor of Drawing and Descriptive Geometry, Massachusetts Institute of Technology; and Eugene H. Uhler, Structural Engineer, United Engineers, Inc., Philadelphia; formerly Assistant Professor of Civil Engineering, Lehigh University. Second Edition, 266 pages 5¾ x 8¾, 246 illustrations, \$2.75.

CONTENTS: Orthographic Projection; Fundamental Constructions; Problems on the Point, Line and Plane; Developable Surfaces and Developments; Surfaces of Revolution; Warped Surfaces; Intersections; Methods of Revolution; Traces; Hip and Valley Angles for Roofs of Buildings; Concurrent Coplanar Forces; Parallel Coplanar Forces; Non-Concurrent Coplanar Forces; Forces in Space; Geology; Mining Engineering; Index.

Send for copies on approval.